



*You always get more
for your money
at Kellyco!*

Toll FREE 1-888-KELLYCO (1-888-535-5926)

www.kellycodetectors.com

Kellyco Metal Detector SuperStore
1085 Belle Ave.
Winter Springs, Florida 32708

Contents

	Page
Assembly	2
Batteries	4
XLT® Quick Start	8
Basic Adjustments	14
1. Target Volume	18
2. Audio Threshold	18
3. Tone (Audio Frequency)	19
4. Audio Disc	19
5. Silent Search	20
6. Mixed Mode	21
7. A.C. Sensitivity	22
8. D.C. Sensitivity	22
9. Backlight	23
10. Viewing Angle	24
Pro Options	25
Audio	27
1. Ratchet Pinpointing	27
2. S.A.T. Speed	28
3. Tone I.D.	29
4. V.C.O.	29
5. Absolute Value	30
6. Modulation	30
G.E.B./Trac	30
7. AutoTrac®	31
8. Trac View	31
9. Trac Speed	32
10. Trac Offset	33
11. Trac Inhibit	33
12. Coarse G.E.B.	34
13. Fine G.E.B.	35
Discrimination	36
14. Disc. Edit	36
15. Block Edit	38
16-17. Learn Accept/Reject	39
18. Recovery Speed	40
19. Bottlecap Reject	41
Display	42
20. Visual Disc.	42
21. Icons	42
22. V.D.I. Sensitivity	43
23. D.C. Phase	44
24. Accumulate	45
25. Average	45
26. Fade	46
Signal	47
27. Transmit Boost	47
28. Transmit Frequency	48
29. Preamp Gain	49
Program Settings Chart	50
Glossary	52
Warranty	53

Assembly

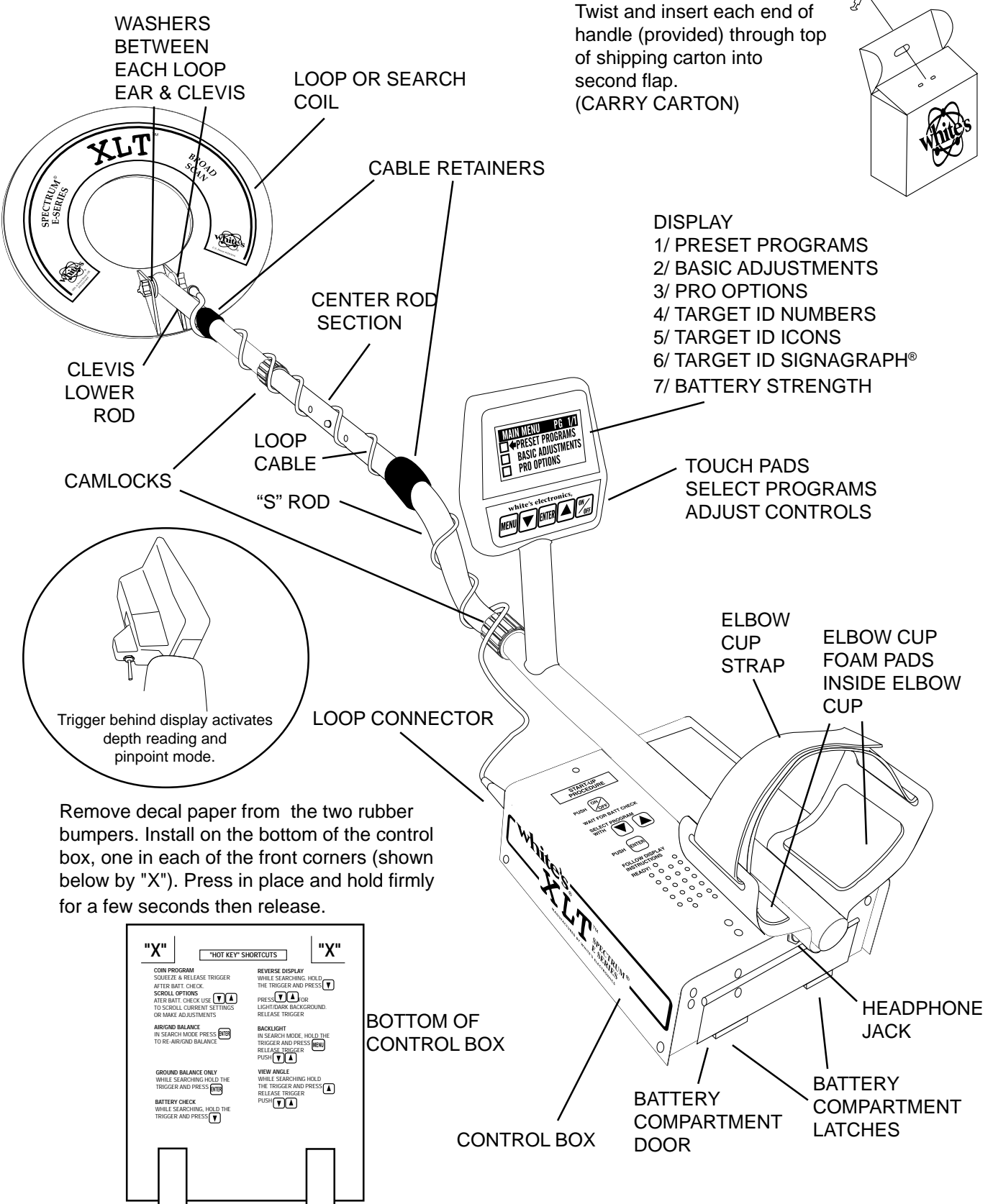

Assembly Instructions

1. Remove all parts from shipping carton and check the assembly page to make sure all parts are present.
2. There are rubber washers between clevis/lower rod and loop ears. **Use only nonmetallic washers, fiber bolt, and thumbnut to secure loop/search coil to clevis/lower rod.**
3. Unlock "S" rod camlock and insert clevis/lower rod into curved "S" rod so that stainless steel spring clip buttons line up and lock into one of the adjustment holes in the curved "S" rod. Turn camlock to secure. The second or third adjustment holes are suitable for average size adults. Individuals 6' or taller should use the fully extended position. Individuals well over 6' tall should purchase the optional *Tall Man Rod*.
4. Unravel loop cable and wind the cable around the clevis and rod assembly, first revolution over the top of the rod. Wind cable all the way to the top of the curved "S" rod, about five revolutions. Use the black cable retainers, one near the loop, and one near the top of the curved "S" rod, to hold the loop cable in place.
5. Unlock control box rod camlock and insert curved "S" rod so that stainless steel spring clip buttons line up and lock into the rod on top of the control box. The "S" rod is designed to curve up toward the display. However, those who prefer to sweep the loop close to their feet may desire to assemble the "S" rod to curve down toward the ground. Turn camlock to secure. Plug loop connector into control box, screw lock ring to secure.
6. Grip the instrument by the handle, with your arm in the elbow cup with strap secure, and sweep the loop/search coil over the floor. If the instrument fit feels uncomfortable, adjust the elbow cup by removing and repositioning the bolt/thumbnut and installing in one of the optional positions. If necessary, readjust clevis/lower rod length with the spring clip buttons so that the search coil can be held near the floor without requiring stooping over.
7. Remove the protective paper from the two black elbow cup foam pads. Carefully align pads on the inside of the elbow cup, one on each side of the center rod, and press firmly into place.
8. Adjust the elbow cup strap so that it is loose enough for you to slide your arm in and out without loosening each time you want to set the detector down. The elbow cup strap provides extra leverage and control. However, some prefer not to use it.
9. Install battery as described in the next section, **decal facing down**, with plastic tab and steel contacts facing toward inside of battery compartment.
10. It should be noted at this point that the detector may not work as expected indoors due to the high degree of metals used in modern construction. It is best to tune and practice out-of-doors to ensure stable, predictable results. Additionally, freshly-buried targets will not produce the normal depth and discrimination results of targets that have been naturally lost and settled in the ground. Due to the abnormality caused by digging a hole in the ground matrix, and the sophistication of the ground rejection circuitry, it may take a number of years for freshly-buried targets to respond at true depths and discrimination accuracy. The best way to determine true detection depth is in real search conditions.

Batteries

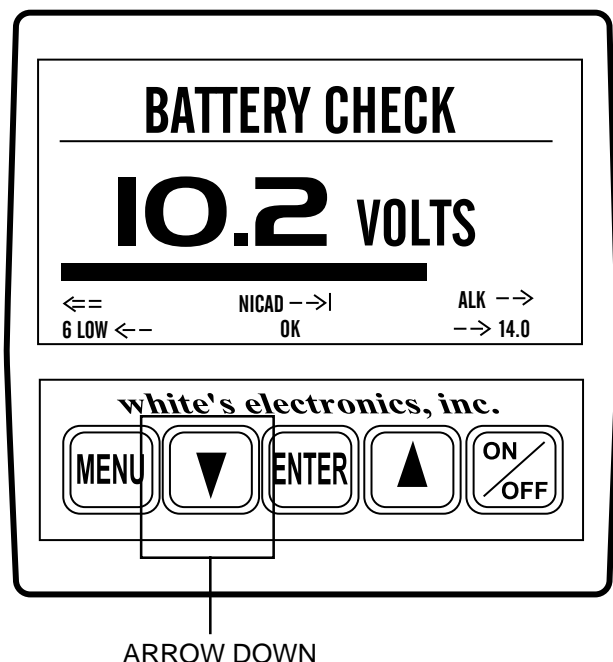

When the instrument is turned on the battery voltage will momentarily appear after the opening display. The detector will then continue to the **MAIN MENU**. To recheck the battery voltage during operation, squeeze and hold the **TRIGGER** and press the **ARROW DOWN** control.

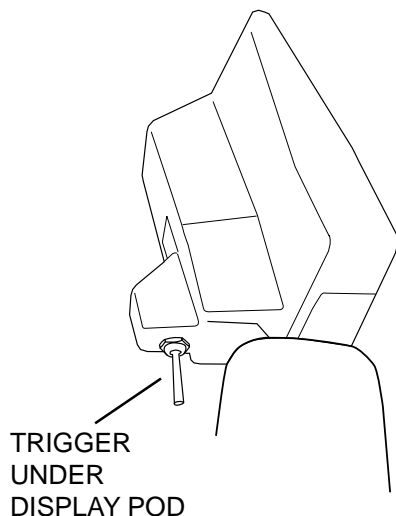

Standard Battery Holder

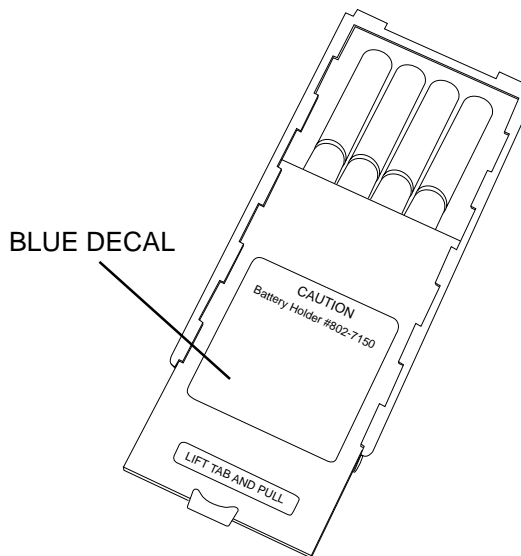

1. The standard battery holder (blue decal) holds eight "AA" cell batteries. Alkalines are recommended for use with this model.
2. Non-alkaline batteries can be used in this holder. When non-alkalines or rechargeable "AA" cells are used, detecting time (before replacement/recharge) may be reduced.
3. "LOW BAT" will automatically appear on the display when the batteries become too low to properly operate the detector.
4. The battery compartment opens by gently pulling down on the front of each of the two latches (on the bottom of the control box) releasing the catch and hinging open the door.

The non-rechargeable battery holder can use many different types of batteries, including rechargeable. This holder is designed for standard size penlight "AA" batteries which should be 50 mm ± .10mm. Battery lengths shorter than this will likely cause problems with this power supply.

Using the Standard Battery Holder

1. Slide open the battery holder lid (decal side of battery holder) by applying gentle upward pressure on the tab of the door so that it unlocks. Slide the door away from the battery box exposing the cell positions.
2. Remove any old cells from the holder. Note the (+) and (-) positions of each cell and the (+) and (-) for each position marked inside the cell tray. Install new “AA” cells **noting carefully the correct (+) and (-) positions.**

If the cells are installed incorrectly, the detector may require service by an Authorized Service Center.

3. Slide the door closed so that it snaps securely.
4. Insert the battery holder into the detector so that the decal is facing down, with the battery holder door tab and metal contact points facing toward the inside of the battery compartment.

Close the battery compartment door and secure the two latches on the bottom of the case. Hook the front of each latch first, then press down on the rear.

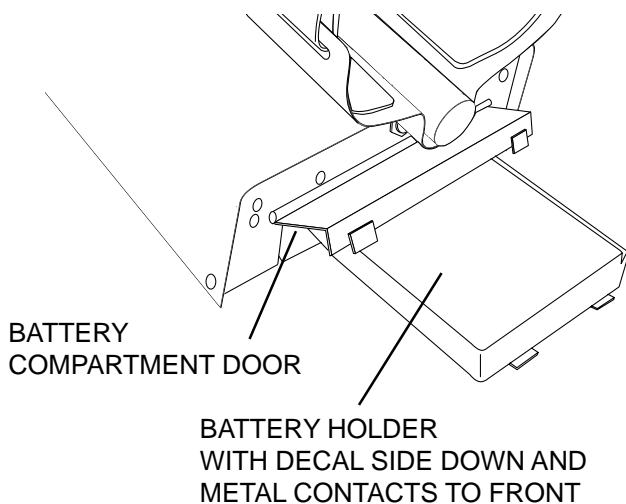

Rechargeable Battery

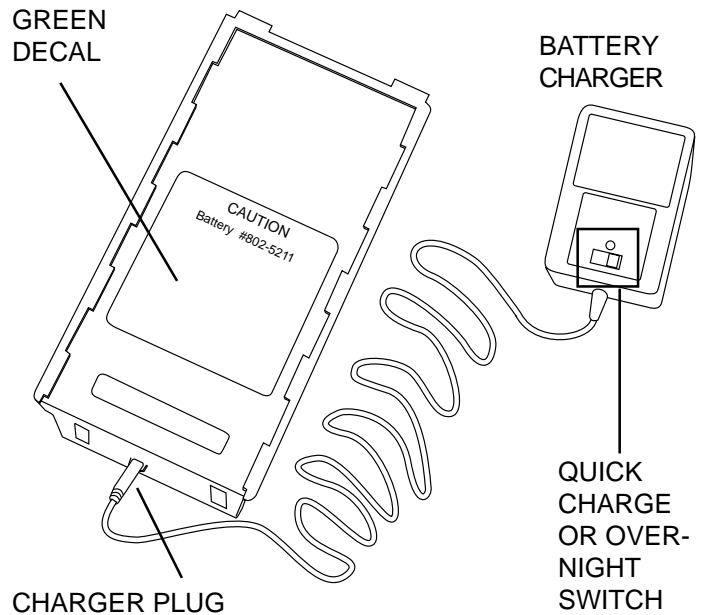

A rechargeable battery (green decal) is provided with your instrument. This battery can be recharged hundreds of times as long as the battery hasn't been stored for extended periods of time or overcharged. Full charge can be achieved anytime during the discharge cycle. When using the QUICK charger setting use the Charging Hours chart on the following page for charge time. A full charge will last ten to fifteen hours of normal use.

Battery life will vary with temperature, the number of targets found, and the exact settings used. Six hours is not unusual for extreme high performance settings, backlight use, or for batteries that have experienced extensive use.

Your charger has a switch on it that selects the QUICK charge, or OVERNIGHT charger options. Always check the position of this switch prior to charging. Always follow the charge hours on the chart on the following page when the QUICK charge setting is used. Over-charging with the QUICK charge setting will damage the system.

Charging

1. There is no harm charging overnight using the OVERNIGHT charger setting regardless of the battery's current condition. However, before charging with the QUICK charger setting, determine battery condition by inserting battery into the instrument and turning the instrument ON. If the instrument will not turn ON, or if voltage tests eight volts or below, charge five hours with the QUICK charge. If the battery voltage tests any other voltage, refer to the Charging Hours chart above for proper QUICK charge time.

2. To charge, insert the charger plug into the battery pack jack, located near the plastic tab and metal contact points.

3. Plug the charger into a standard wall outlet. (110 volts for USA models).

4. Again, the QUICK charger setting uses the above chart for a specific charge time. OVERNIGHT is designed to charge the battery in as little as fourteen hours. However, no harm will come to the system leaving it charging for several days.

5. It is normal for the battery and charger to get warm during use. However, if either the battery or the charger gets too hot to hold or deforms due to the heat, discontinue use and return for testing.

Using the Battery Charger on Quick Charge Setting

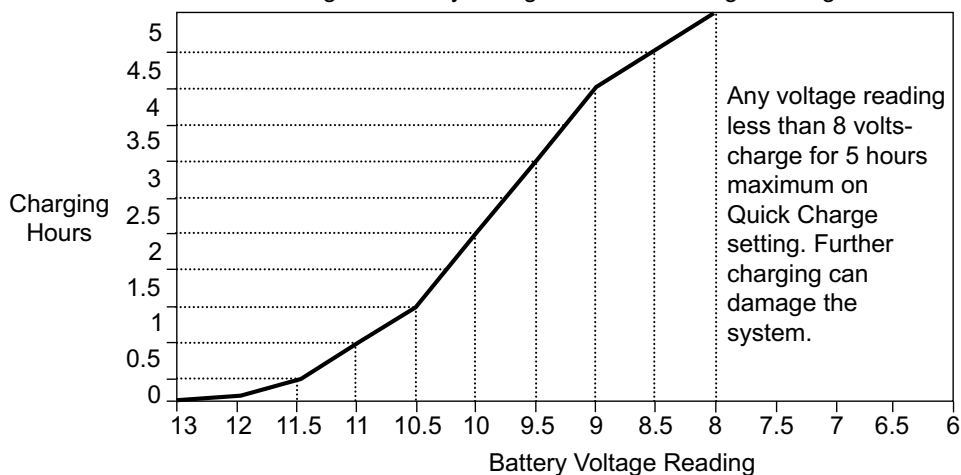

6. The battery will lose its charge during storage. If stored inserted in your instrument, this loss will be more noteworthy. It is recommended that the battery be removed from the instrument during periods of storage. It is not advisable to store rechargeable batteries for long periods of time without use. If however, storage is necessary, store without a charge (discharged).

7. Do not discharge the battery in devices other than your metal detector. Unnecessary discharging and/or an absolute discharge will reduce battery life and may damage the battery. Unlike older rechargeable battery designs, the rechargeable battery provided with your detector can be recharged at any time. *Regardless of whether or not it already has a partial charge, memory will not occur.*

8. White's has provided the leading edge of rechargeable battery technology with your instrument. Disregard all advice which conflicts with the above recommendations. Care for batteries provided by other manufacturers, or with other White's models, may vary.

Battery Life & Memory

Volatile memory temporarily holds any program changes or settings not yet saved in a Custom Program. *Short-term* or volatile memory is retained so long as a good battery remains in the detector. To recover volatile memory immediately squeeze and release the TRIGGER once the detector is turned ON. If the battery is removed all volatile memory is lost. *Long-term* memory (programs saved in Custom Programs) is automatically saved for up to ten years regardless of whether a battery is in the detector or not.

When using fresh batteries, the voltage will initially check somewhere in the 10 to 14 volt area. Unlike standard batteries, the rechargeable battery voltage will quickly drop to between 9 and 10 volts and plateau there for most of its life. Once the rechargeable battery voltage drops below this plateau, it will quickly drop below a usable voltage level (eight volts) and thus require a recharge. *Low Battery* will automatically appear on the display when the battery reaches eight volts.

Like a personal computer, there are times (such as low battery conditions) when the microprocessor of a metal detector becomes out of sequence with the rest of the circuitry. This is often noted by peculiarities in the non-discrimination or pinpointing (TRIGGER squeezed) modes. Symptoms may be blaring or silent non-discriminate or pinpoint modes, depth indication inaccuracies or general abnormal operation. To correct such difficulties "re-boot" by:

1. **Install a good battery.**
2. **Turn ON wait for MAIN MENU to appear.**
3. **Open battery door and remove battery while detector is still ON.**
4. **Wait one minute, re-install battery, turn detector ON, and check for proper function.**

Use of maximum backlight may reduce battery life by up to 50%, depending on battery type.

Rechargeable batteries gradually deteriorate. As they age they do not provide the life-per-charge they did when new. This is expected, and not grounds for replacement under warranty. Additionally, a damaged initial cell, which is caused by over-charging with the QUICK option, *is not replaced under warranty*. Only cell failure through normal use, or a defect due to a problem with a White's warranted XLT® charger, is covered.

XLT® Quick Start

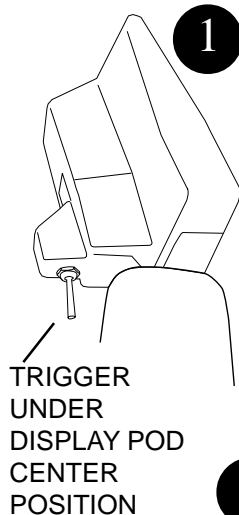

TRIGGER UNDER DISPLAY POD CENTER POSITION

- 1
- 2
- 3
- 4
- 5
- 6
- 7
- 8

WHITE'S SPECTRUM XLT
WHITES ELECTRONICS INC (C) 94
SOFTWARE VERSION # 1.1

white's electronics, inc.

MENU ▼ ENTER ▲ ON/OFF

BATTERY CHECK

10.2 VOLTS

←= NICAD →=1 ALK →→
6 LOW ←= OK →→ 14.0

MAIN MENU PG. 1/1

← PRESET PROGRAMS
 BASIC ADJUSTMENTS
 PRO OPTIONS

(press ENTER)

PROGRAMS PG. 1/3

← COINS
 COIN & JEWELRY
 JEWELRY/BEACH

(press ENTER)

RAISE LOOP TO WAIST LEVEL THEN PRESS ENTER

←

(press ENTER)

LOWER LOOP TO GROUND SURFACE THEN PRESS ENTER

←

(press ENTER)

+88 (25%)

Bar graph from -95 to +95 with 0 in the middle.

(LIVE SEARCH SCREEN)

XLT® Quick Start Instructions

After you have assembled the XLT® and inserted the battery pack, follow these simple steps to start treasure hunting!

- 1 With the TRIGGER in the center position, press the ON/OFF control and an automatic sequence will begin.
- 2 The display will momentarily show an opening screen which lists the **software version**.
- 3 The display then shows a **battery check** screen.
- 4 The last automatic display screen to appear is the **MAIN MENU**. Press the **ENTER** control. ("BEEP")
- 5 The Preset Program **COINS** will appear on the MENU. Press **ENTER**. ("BEEP")
- 6 You will be prompted to raise the search coil (loop) to waist level. Press **ENTER**. This **air balances** the XLT®. ("BEEP")
- 7 Next, the **ground balance** prompt appears asking you to lower the search coil (loop) to the ground. Press **ENTER**. Ground mineralization will be balanced out. ("BEEP")
- 8 The last screen will be the live search screen. You will hear the THRESHOLD "hum". Sweep the search coil over the ground and listen for a solid repeatable/consistent beep, then look at the display. The icons tells what likely coin lies below. V.D.I. number/chart on top of control box and SignaGraph® provide greater detail. Squeeze the trigger for pinpointing and depth and it's time to dig!

Search Fundamentals

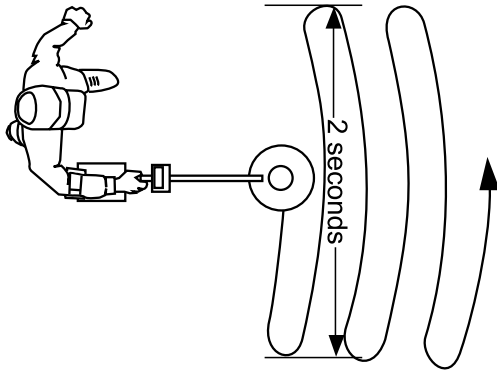

The loop/search coil must be in motion (sweeping from side-to-side) for this instrument to respond to metal. Practice a smooth sweep of the loop from side-to-side keeping the loop close to the ground throughout the swing. **Each pass of the loop should take approximately two seconds from right to left, two seconds to return from left to right.**

Walk forward slowly. Take small steps no greater than half normal strides. Make sure each pass of the loop overlaps the last by at least half the length of the loop. Do not lift the loop at the end of each swing. Keep it close to the ground at all times.

To become comfortable with sweeping the loop takes some practice. Try to loosen up and find a comfortable grip on the handle. Premature fatigue may result from gripping the handle too tightly, improperly adjusted rod or elbow support, and limited body movement. Hold the handle loosely. Adjust the rod and elbow support for comfort and keep the elbow strap loose. Use your arm, shoulder and even your back a little to allow a smooth even sweep of the loop.

Now that you're sweeping the loop smoothly over the ground, you will notice that the detector starts making sounds (*beeps*). **Not all sounds are good targets; some trash targets also make the detector beep.**

As the loop is swept over the ground, ignore the display and concentrate on the sounds the detector makes.

As the loop is passed over metal that is likely trash, the sound will be inconsistent. Trash targets typically produce a shorter, sputter-type sound, that is often broken or double in nature. Place a steel-pop bottlecap on the ground. Pass the loop over it several times to become familiar with this sound at different loop sweep speeds. Note that an aluminum twist-off bottlecap **cannot** be used as it is a different type of target. Also note that very old rusty bottle caps may start reading as quarters due to the elimination of the iron alloy through deterioration. Once familiar with the sound typical bottle caps produce, an operator may pass over such targets and continue searching without consulting the display information, saving more time for evaluating possible good targets.

As the loop passes over metal that is likely a good target, a more consistent and smooth sound will be heard. A good target typically produces a longer, more solid sound. Place a quarter on the ground and sweep the loop over it several times to become familiar with the sound of a good target.

Why Air/Ground Balance?

When the display prompts you to, AIR BALANCE by holding the loop at waist level and press ENTER. The XLT®'s circuits are being prepared for ground balancing by measuring temperature and other variables that affect electronic circuits. The XLT® "beeps" and you lower the search coil to the distance above the ground that you will be searching. Press ENTER to have the XLT® "cancel/track out" or GROUND BALANCE the ground mineralization. The XLT® then automatically "tracks out" the varying mineralization as you continue to search.

Live Search Screen - what is it telling me?

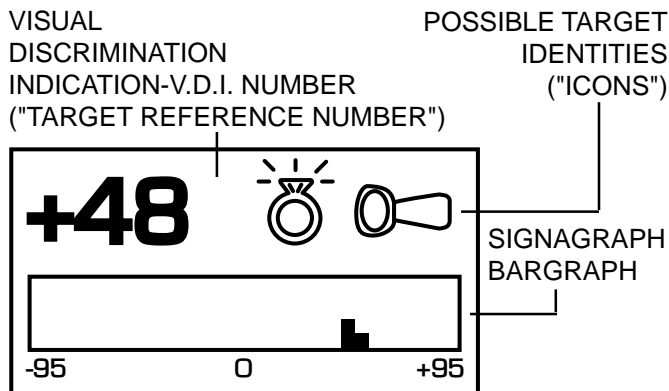

1. V.D.I. Visual Discrimination Indication ("target reference number")

In the upper left hand-side of the display there is a V.D.I. number that corresponds to the V.D.I. SCALE painted on the top right-hand side of the control box. It also corresponds to the Discriminate Edit feature allowing you to reject or accept targets based on their V.D.I. reference number. There are "+" numbers for non-ferrous (not of iron) targets, and "-" numbers for ferrous (iron) targets. Rejected V.D.I. numbers may not appear if the VISUAL DISCRIMINATION feature is ON. Reasonably consistent V.D.I. reference numbers (\pm five digits), in a desirable area of the chart is a vote for digging the target.

2. Possible Target Identities ("Probable or most likely Target")

To the right of the V.D.I. number, possible target identities will be represented graphically. These graphics are called ICONS. A fairly consistent indication of a desirable target is another vote to dig the target. One or two possible target icons may appear. There is significance to which icon appears first. The first target to appear is always the most likely, the second is another possibility slightly less likely than the first.

3. SignaGraph™

The SignaGraph™ at the bottom of the display provides a final vote as to whether or not the target should be dug.

A. Sweep the loop over the target several times and look at the SignaGraph™. The SignaGraph™ automatically clears itself (FADE RATE) so that it doesn't fill the screen with information from past loop sweeps. An operator has limited time to look at the SignaGraph™. If you want to look at the information again, sweep the loop over the target several more times. The fading of the SignaGraph™ information can be slowed or speeded (FADE RATE) to operator preference. This is completed in the PRO OPTIONS under DISPLAY. Automatic AVERAGING and/or ACCUMULATING of SignaGraph™ information is also available (See PRO OPTIONS).

B. Valuable targets will show up on the positive side of the graph. The positive area of the chart is the section located to the right of the zero.

C. Look for consistency. In ideal conditions, coins and jewelry produce one or two bars to the right of zero. Trash produces several bars, sometimes on both sides of zero.

D. In less than ideal conditions, coins may produce a wider pattern of bars. Most trash targets produce a recognizably different pattern than valuable targets.

E. One of the most visual benefits of the SignaGraph™ is the ability to show a *smear* pattern on iron targets that often fool the other methods of identification. An iron target will likely show definite bars on both the negative and positive sides of the SignaGraph™, often *smearing* all the way across the entire chart. Valuable targets should not produce such obviously wide patterns. In very bad ground conditions, a good target may have a few small bar segments in the negative area due to mineralization. However, the pattern will show mostly positive bars, in a fairly narrow tall group.

Live Search Screen Samples

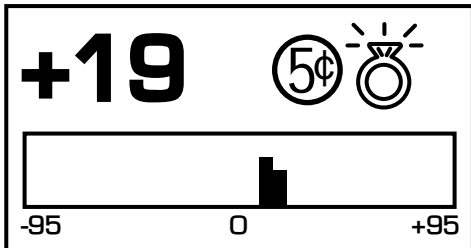

Nickle, or possible ring. Sometimes a small (or half) pull tab will produce this indication

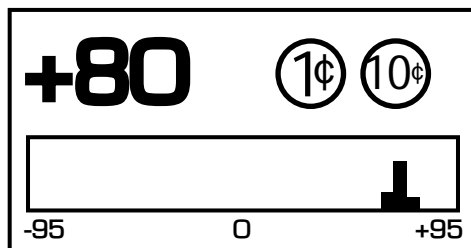

Penny or a dime. If the screw cap and penny ICON are displayed, the target can be an Indian Head or zinc penny.

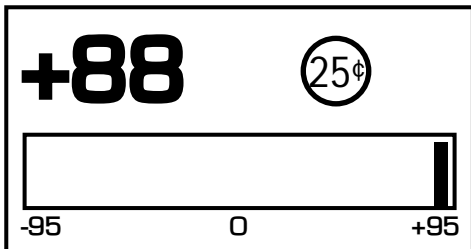

Quarter. Could be a worn half, or large silver jewelry.

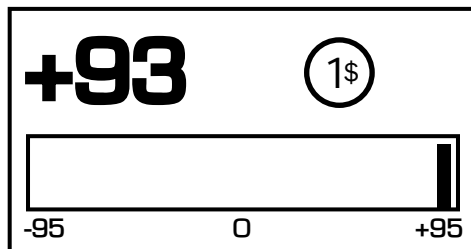

Dollar. Large non-iron can also produce this indication (large brass jar lids).

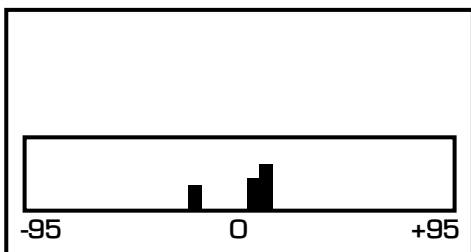

IRON. REJECT targets will produce only a SpectraGraph™ if VISUAL DISC. is ON

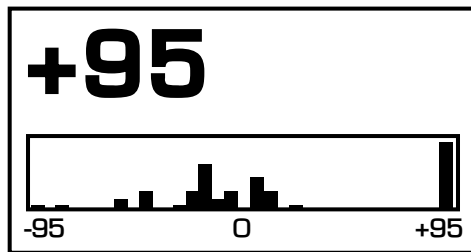

IRON. +95 ACCEPTED or VISUAL DISC. OFF

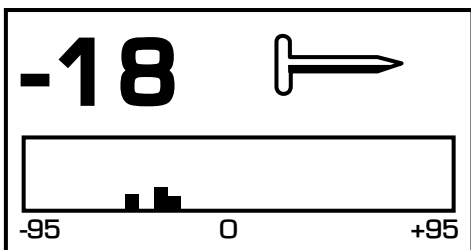

IRON. -18 ACCEPTED or VISUAL DISC. OFF.

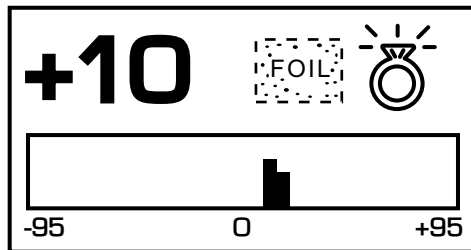

Foil. Possible ring. +10 ACCEPTED or VISUAL DISC. OFF.

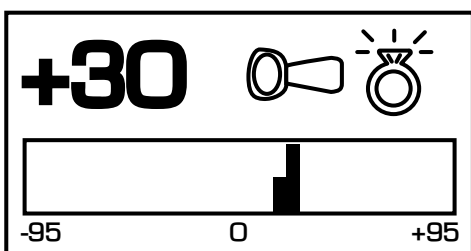

Pull tab. Possible ring. +30 ACCEPTED or VISUAL DISC. OFF.

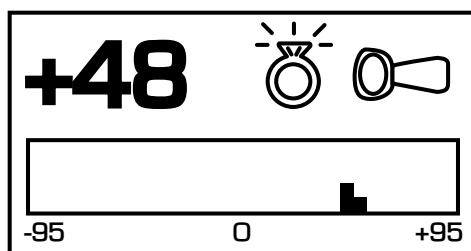

Ring. Possible pull tab. +48 ACCEPTED or VISUAL DISC. OFF.

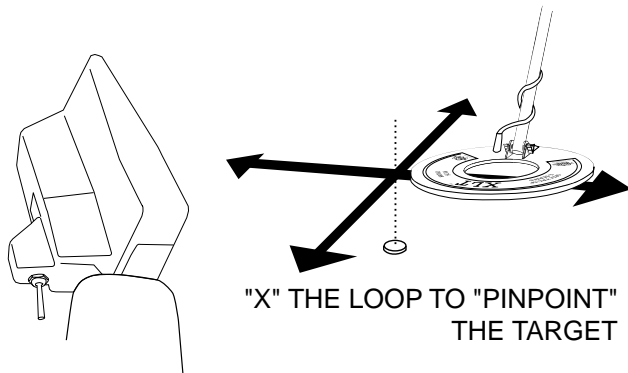

SQUEEZE TRIGGER

DEPTH SCREEN
DISPLAYED WHEN
THE TRIGGER
IS SQUEEZED

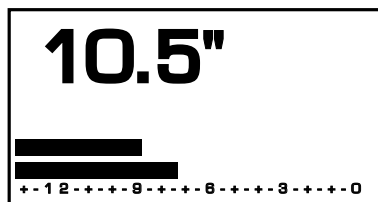

Advanced Pinpointing Techniques

1. Targets that are near the surface, because they give a wider response, are harder to pinpoint than deep targets. If the trigger is held and the loop swept over the area, you may note a shallow depth indication. Lifting the loop slightly above the ground, releasing and re-squeezing the TRIGGER and again "X" ing the target will aid pinpointing.
2. In the Basic Adjustments, DC Sensitivity (non-motion) directly controls the pinpointing mode. Lower DC Sensitivity settings pinpoint shallow targets better.
3. In the PRO OPTIONS under AUDIO, V.C.O. (Voltage Controlled Oscillator) significantly aids pinpointing.
4. The depth reading has two indication bars. The top bar shows the current distance from the target, and the bottom bar shows a memory of the strongest reading. These two bars will be even with each other when the loop is directly over the center of the target.

Pinpointing the Target

Once the decision has been made to dig, move the loop off to one side of the target area, squeeze and hold the TRIGGER on the handle, and "X" the loop over the spot where you believe the target to be. Note that the TRIGGER also has a locked forward position that accomplishes the same thing as squeezing and holding it.

While the TRIGGER is being held, the loop doesn't need to be moving to detect the target. The loop may be moved slowly over the area. The display will indicate depth in inches and will also show the strongest reading to aid in pinpointing exactly where to dig. The shallowest reading on the depth display, the loudest sound coming from the speaker, and the two bars lining up with each other, indicate the center of the target. Don't forget to "X" the target as pinpointing cannot be accurate unless the target is swept from at least two different directions. Once pinpointing is complete, release the TRIGGER, or return it to the center position.

Pinpointing takes practice. The standard loop provided with the Spectrum® is a high-powered, 9.5 inch design. This loop's strongest traits are in the detection depth and ground coverage areas. If pinpointing becomes difficult or critical, an optional smaller loop is suggested. The smaller loops have advantages in high trash areas and pinpointing, but will **not** detect as deep as the standard 9.5 inch size.

Ready to Dig

Permission - Prior to searching and digging you must have permission to search private property, from the owner or caretaker.

Laws - Know the laws that apply to the area you are going to search. Laws vary a great deal with the City, County, State, and Country, regarding the use of metal detectors. Be respectful of private property, public property, and the laws which govern the use of metal detectors.

Tools - Care must be taken to dig in a way that is friendly to the landscape. Tools and methods vary a great deal with the area, season, and types of target you are recovering. Check with your dealer for recommended tools and methods for your area.

Trash - When searching, remove all trash you come across. This not only makes your future searches of the area more productive; it promotes the hobby of metal detecting.

Get Involved - Your dealer knows of metal detecting clubs and organizations which promote and protect the hobby. A club is a great way to not only learn good detecting habits, but to gain permission to search areas as a group as well as have organized competition hunts.

Factory Preset Programs

Reached from the MAIN MENU, the factory PRESET PROGRAMS give a quick start for:

Coins: general purpose settings, discriminates (rejects) most common junk items like nails, foil, pull tabs, and hot rocks; and responds to most coins and large jewelry. Use in lawns, parks, and playgrounds where lots of trash rejection is desired.

Coin & Jewelry: less discrimination (less trash rejection), desirable because of the high degree of variance found in jewelry alloys. More digging required. Good program for lawns, parks, and playgrounds. Use screen more than sound.

Jewelry & Beach: similar to Coin & Jewelry, but Pro Options are changed for salt water.

Relic: even less discrimination than Coin & Jewelry or Jewelry & Beach, all types of metals except small iron items like nails, and some stainless steel. Brass, lead, aluminum, as well as copper, silver, and gold all respond solidly. Ferrous (iron), such as large nails, weapons, and cannon ball fragments will also respond. Suitable for all significant targets and separate ferrous/non-ferrous by display indications.

Prospecting: NO AUDIO DISCRIMINATION. All metals respond with *beep*. But V.D.I. numbers show only for metals that could be gold. Dig only V.D.I. number (possibility gold) targets and avoid iron. Targets which cause an audio response, without causing a V.D.I. number to appear on the display, are not likely to be gold nuggets. Although high-frequency gold-shooting detectors will respond better, this mode will offer good results for the occasional nugget hunter by responding to nuggets in the nine-grain and heavier category.

Basic Adjustments

Basic Adjustments - what do they do?

1. **TARGET VOLUME** - How loud a target beeps when detected.
2. **AUDIO THRESHOLD** - The slight hum or background sound heard continuously during searching.
3. **TONE (AUDIO FREQUENCY)** - Selects the frequency or pitch of sound the detector produces.
4. **AUDIO DISCRIMINATION** - The ability to reject trash, different sounds for different types of targets.
5. **SILENT SEARCH** - The ability to operate without the threshold or background hum.
6. **MIXED-MODE** - DC non-discriminate mode, working simultaneously with AC discrimination mode.
7. **A.C. SENSITIVITY** - Degree instrument is responsive to signals in the discriminate (motion) modes.
8. **D.C. SENSITIVITY** - Degree instrument is responsive to signals in non-discriminate (non-motion) modes.
9. **BACKLIGHT** - Used in dark conditions to light the display improving visibility.
10. **VIEWING ANGLE** - Adjusts the display for low or high temperature visibility.

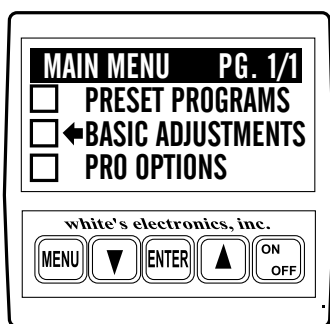

(press ENTER)

ADJUSTMENT
EXAMPLE:

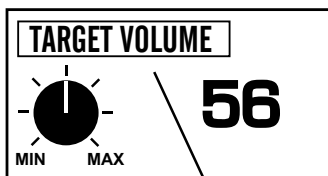

(press ENTER)

RECTANGLE AROUND
THE TITLE MOVES TO
THE SETTING

USE ARROW KEYS TO
ADJUST THE SETTING
UP OR DOWN

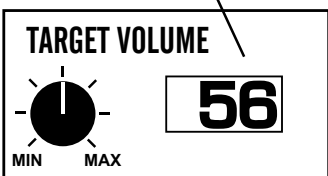

TIP - To quickly increase to maximum, hold ENTER and press ARROW up. To quickly decrease to minimum, hold the ENTER and press ARROW down.

ADJUSTMENT
EXAMPLE:



Basics of Basic Adjustment

After you have had some field experience, you may want to make some changes to the basic settings of your detector. **From the search mode press MENU.** At this point, the MAIN MENU will appear on the display. Use the ARROW controls to **move the pointer to Basic Adjustments**, and then **press ENTER.** You may now **use the ARROW down control to scroll** through the Basic Adjustments.

Using the first adjustment screen (TARGET VOLUME) as an example, the screens with a *graphic control knob* require you to first **press ENTER** then **use the ARROW up and down controls to adjust.** Note when ENTER is pressed the square around the title moves to the setting, indicating you are ready to make adjustments with the ARROW controls. **After adjusting press MENU** and use the ARROW controls to continue viewing / setting other Basic Adjustments, or squeeze and release the TRIGGER to begin searching

Adjustment screens with an on/off selection need only for you to press ENTER to change setting. Pressing ENTER again changes back to the original setting.

More Basics

All the MENU items are tied together so that the ARROW up and down controls scroll through every adjustment screen. If you continue to press the ARROW *down* you can go beyond the last BASIC ADJUSTMENT (View Angle) and into the PRO OPTIONS. If the ARROW *up* control is pressed after VOLUME, you will be scrolling backwards through the options starting with the end of the Preset Programs, then the MAIN MENU, then the end of the PRO OPTIONS.

An important feature of the ARROW controls; If a BASIC ADJUSTMENT has been made (for example Volume) and the trigger has been squeezed and released to return to a search mode, you can return to the volume adjustment simply by pressing either of the ARROW controls. This shortcut returns to the last adjustment that was made thereby allowing an operator to switch directly from a search mode to the adjustment currently being fine tuned. This feature is desirable as you start using BASIC ADJUSTMENTS or PRO OPTIONS that are located further down the menu listings, or any adjustment that may require some trial and error to find the appropriate setting.

If care is taken to use a desired adjustment screen last (just prior to squeezing and releasing the TRIGGER for a search mode), Custom Programs (such as a competition hunt program) can use this ARROW RETURN feature to allow quick easy access to the most used feature (Transmit Frequency). Use that feature (adjustment screen) last, just prior to squeezing and releasing the TRIGGER for searching. Then during searching, press either ARROW to return directly to that adjustment screen.

"Hot Key" Shortcuts

"HOT KEYS" will save time as they allow easy access, from the search mode, to the most needed adjustments. They are painted on the bottom of the control box for field reference.

COIN PROGRAM - Squeeze & release TRIGGER after automatic battery check.

SCROLL OPTION - After battery check, use ARROWS to scroll all the current settings / menus.

AIR/GROUND BALANCE - In search mode, press ENTER to re-Air/Ground Balance.

GROUND BALANCE ONLY - While searching, hold the TRIGGER and press ENTER.

BATTERY CHECK - While searching, hold the TRIGGER and press ARROW *down*. Squeeze and release TRIGGER to return to searching.

REVERSE DISPLAY - While searching, hold the TRIGGER and press ARROW DOWN. Press ARROWS for light/dark background. Light or dark background will not change battery life. It will make the display easier for some to read, particularly in certain light conditions. It will work in combination with backlight. Reversed display is only accessible through the "HOT KEYS".

BACKLIGHT - In search mode, hold TRIGGER and press MENU. Release TRIGGER, press ARROWS to set.

VIEW ANGLE - While searching, hold the TRIGGER and press ARROW *up*. Release TRIGGER, press ARROWS to set.

Custom Programs - Saving your Basic and Pro Option adjustments for future use.

Save custom settings in any one of four custom program positions. They will remain permanently in the XLT® memory regardless if the machine is turned off or the battery removed. Custom Programs can be changed at any time by saving new settings over a previously saved custom program.

1 SQUEEZE TRIGGER

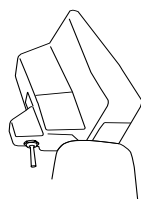

THEN PUSH MENU

2

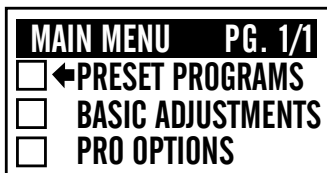

PRESS ENTER FOR PRESET PROGRAMS



SCROLL DOWN WITH ARROW KEYS

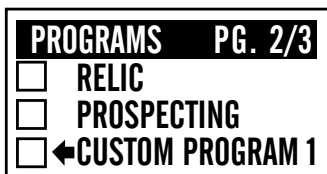

PRESS ENTER

3

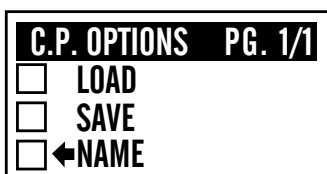

PRESS ENTER

4



USE THE ARROW KEYS TO SCROLL THE FLASHING SYMBOLS, PRESS ENTER

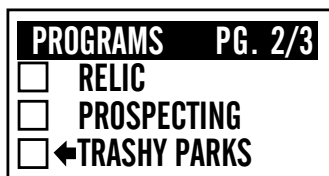

PRESS MENU

1 Once all of the changes you desire have been made to any Preset Program or existing Custom Program, squeeze and release the TRIGGER as if to search. Then push MENU for MAIN MENU.

2 Use the ARROW controls to select one of the four Custom Programs then press ENTER.

3 You now must make one of three choices (use the ARROW controls to make your selection):

A. LOAD will activate a prior custom program stored in that position. After you have SAVED or NAMED a program, you can select LOAD and press ENTER, to use that program.

B. SAVE saves your current settings in that custom position with either a generic name or a prior custom name you may have applied. Selecting SAVE and pressing ENTER saves the current program.

C. NAME is the preferred method. Select NAME and press ENTER. You may now use the ARROW and ENTER controls to name your custom program. NAME automatically SAVES, once you have chosen a name and pressed MENU.

4 To NAME, use the ARROW controls to select the first symbol, number, or letter of the name and press ENTER. Use the ARROW controls to select the second symbol, number, or letter of the name, press ENTER. And so on using up to sixteen digits. To leave a space, use the ARROWS to select the point where no symbol or letter appears and press ENTER. If you make a mistake and press ENTER when the digit is not as you desire, simply keep pressing ENTER until that digit is again flashing, then use the ARROWS to select the correct digit and again press ENTER. It is wise to name the custom program something that relates to what it is used for. For example "TRASHY PARKS", "SMALL LOOP", "GHOST TOWN", "NIGHT HUNT", "COMPETITION", etc. Once the name is fully assembled press MENU.

5. Once you have SAVED and pressed ENTER, or NAMED and pressed MENU, there are four directions you can go:

A. Squeeze and release the TRIGGER to continue searching using your new custom program.

B. Press ENTER, select LOAD and press ENTER to continue searching using your new custom program.

C. Press MENU to return to choose or develop a different program than what you stored.

D. Turn the detector OFF.

6. When the detector is turned back on, regardless of whether a battery pack was left in the detector or not, your custom program will be ready for you to use again and again. Simply select it, press ENTER, select LOAD, and press ENTER again. Follow the on-screen instructions for Air/Ground Balance and then search.

7. If you SAVE or NAME a program, then decide you no longer want to keep it, you can replace it with a

new program using the same procedure as described above. The old program can only be erased when a new program is stored in that position.

8. You can NAME a custom program and at a later date replace the program while maintaining the same name. Develop the changes first to any program, then use the SAVE method which maintains the old name while storing the new program. To keep the same program with a new name, first LOAD that custom program, Air/Ground Balance, then press MENU and go to that custom position and press ENTER. Now select NAME and press ENTER. You can now develop a new name for the old program.

Other Custom Program info

Ground Balance - When a Custom Program is stored, the Ground Balance setting last used with that program is also stored. This has advantages particularly for those who manually set the Ground Balance for speciality applications. The automatic Air/Ground Balance sequence will always override manual settings. To access the last Ground Balance setting used with a Custom Program, first select the desired Custom Program then press ENTER. Select LOAD and press ENTER. Do not Air/Ground Balance as the display suggests, simply squeeze and release the TRIGGER. The last Ground Balance setting will then be in use. If an appropriate Air/Ground setting is not available, the instrument will automatically require a new Air/Ground Balance.

Return ARROW Key - The last Basic Adjustment or Pro Option screen used is remembered by your Custom Program. From the search mode, either ARROW control will access the last Basic Adjustment or Pro Option screen used. This allows easy access to the most used adjustment (such as Transmit Frequency) for a custom competition hunt program.

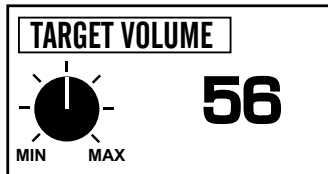

Tip - Select the loudest comfortable level, lower with headphones, higher without.

1. Target Volume

How loud a target *beeps* when detected.

Select TARGET VOLUME with the ARROW controls and press ENTER. The current volume level sounds continuously. The number designating the current level is shown on the right side of the display. To the left, the graphic knob indicates the relationship of the current setting to minimum and maximum levels.

Use the ARROW controls to select the volume level you desire. Volume level will select the loudest possible sound a shallow target can produce. High volume levels will slightly reduce battery life.

Press MENU and use the ARROWS to continue viewing and or adjusting Basic Adjustments, or Squeeze and release TRIGGER to begin searching.

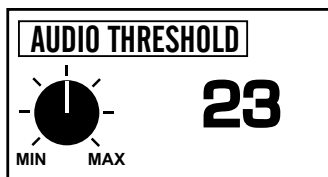

Tip - Select the lowest level you can still hear.

2. Audio Threshold

The slight hum or background tone which is normally heard continuously during searching.

Select THRESHOLD with the ARROW controls, and press ENTER. The current threshold level will sound continuously. The number designating the current level is shown on the right side of the display. To the left the graphic knob indicates the relationship of the current setting to minimum and maximum levels. Note that the maximum threshold level (42) is well below the minimum VOLUME level. Thus with the THRESHOLD at maximum, and the VOLUME at minimum, the detector will still respond to metal. Use the ARROW control to select the threshold level you desire. High threshold levels will slightly reduce battery life.

Press MENU.

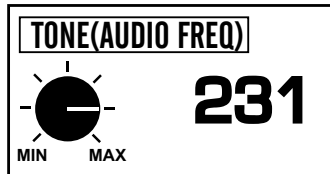

Tip - If you have trouble hearing high frequencies select low TONE levels (low numbers). If you have trouble hearing low frequencies, select high TONE levels (high numbers).

3. Tone (Audio Frequency)

Selects the frequency or pitch of the sound the detector produces. This is different than Transmit Frequency which is described in the Pro Options under Signal .

Select TONE (AUDIO FREQ.) with the ARROW controls and press ENTER. The current TONE will sound continuously. The number designating the current level is shown on the right side of the display. To the left, the graphic knob indicates the relationship of the current setting to minimum and maximum levels. Low frequencies, from about 100 down, begin to *pulse*. Select an audio frequency that you can hear comfortably and provides the best definition for your ears. Press MENU.



Tip - Use AUDIO DISC ON for trash rejection, AUDIO DISC OFF for detection of all types of metals.

4. Audio Disc.

The ability of the detector to reject trash by producing different sounds for different types of targets. Trash is rejected by going silent or producing a broken "cut-short" sound. Valuables are detected by a smoother more solid sound.

Select AUDIO DISC. with the ARROW controls, use the ENTER control to turn AUDIO DISC. ON or OFF. When ON, specific targets will be accepted or rejected based on the Program currently in use. Audio Disc. turns ON or OFF the entire audio discriminate feature. When OFF, all types of metals produce an audio tone (*beep*). Only by selection of a different Program, or by entering the Pro Options under Discrimination, can specific target's (V.D.I. numbers) acceptance or rejection criteria be altered. Press ENTER.

SILENT SEARCH	
<input type="checkbox"/>	ON
<input checked="" type="checkbox"/>	OFF
TO CHANGE PRESS ENTER	

Tip - A threshold hum is recommended as it often fades over rejected targets providing information about targets and ground conditions. If the constant noise bothers or distracts you and reduced AUDIO THRESHOLD doesn't help, select SILENT SEARCH.

5. Silent Search

The ability of the detector to be operated without the threshold or background hum that is normally heard continuously during operation. The instrument is silent until a target is detected.

Select SILENT SEARCH with the ARROW controls and use the ENTER control to turn SILENT SEARCH ON or OFF.

AUDIO DISC. needs to be ON and MIXED MODE needs to be OFF for SILENT SEARCH to perform properly.

In Pro Options the Discriminate feature can be used to accept all metal targets while using SILENT SEARCH. It is not possible to achieve a non-motion searching mode with SILENT SEARCH ON. When SILENT SEARCH is ON the all metal pinpointing mode continues to produce a threshold. This may not be noticed, as once the pinpoint mode detunes for better target center locating the threshold is not present. However, releasing, re-squeezing, and holding the TRIGGER with the loop at waist level a threshold will be noted. Press ENTER.



Tip - Advanced operators can gain extra depth by monitoring the all-metal and discriminate channels simultaneously, checking depth and digging targets too deep for the discriminate channel alone. For even more information about the target, Pro Options TONE I.D. and or V.C.O. can be added to produce a truly unique advanced users mode.

6. Mixed Mode

A unique hybrid operating mode. It is an all-metal (DC non-motion, non-discriminate) mode, working simultaneously with a discriminate (AC motion discrimination) mode. It is two modes, one detecting everything and another discriminating, operating at the same time.

Select MIXED MODE with the ARROW controls, press ENTER control to turn MIXED MODE ON or OFF.

AUDIO DISC needs to be ON and SILENT Search needs to be OFF, for MIXED MODE to perform properly.

When Mixed Mode is on, all types of metals will produce a sound (beep).

Discrimination Channel - When the loop is in motion, targets accepted by the discriminate program will produce a high-pitched *beep*. Targets rejected by the discriminate program will produce a lower pitched *beep*. High-pitched or low-pitched *beeps* are directly determined by the discrimination settings. An operator can select discriminate settings through the selection of an entire Program or by adjusting the accept and reject V.D.I. numbers in the Pro Options under Discrimination (EDIT).

All Metal Channel -When the loop is not in motion, or moved slowly, all types of targets will produce the same low-pitch *beep*. All-metal channel will by nature detect deeper than the discrimination channel. Deeper targets will produce a lower volume sound when the loop is moved slowly over the area.

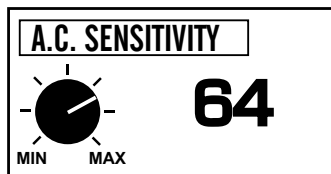

Tip - Preset levels work well for most conditions. Reduced levels will improve stability in difficult conditions. Increased levels will improve detection depth if stability can be maintained.

Tip-Remember that once the TRIGGER is squeezed and released to go to a search mode, you can return to the last adjustment screen used by pressing either ARROW control.

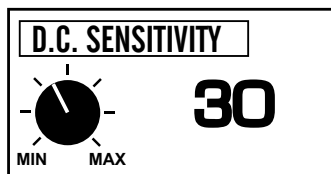

Tip - Typically, lower D.C. SENSITIVITY settings pinpoint shallow targets far better than high settings. High settings will however, produce more pinpointing (as well as non-discriminate mode depth). Pinpointing (TRIGGER squeezed), MIXED-MODE, and V.C.O. AUDIO are dramatically impacted by the D.C. SENSITIVITY setting.

7. A.C. Sensitivity

Used to select the appropriate sensitivity (degree that the instrument is responsive to signals) while being used in the discriminate modes (those which require movement of the loop).

Select A.C. SENSITIVITY with the ARROW controls, and press ENTER. Use the ARROW controls to set the level of sensitivity shown by the number on the right. Press ENTER.

Sensitivity levels adjust detection depth and also have a direct effect on detector stability. A.C. SENSITIVITY levels should be selected carefully to allow stable, predictable performance. Set a lower level if the detector behaves erratically.

8. D.C. Sensitivity

Used to select the sensitivity (degree that the detector is responsive to signals) while the detector is being used in non-discriminate modes. These are modes that do not require movement of the loop to respond. D.C. SENSITIVITY fine tunes stability and pinpointing.

Select D.C. SENSITIVITY with the ARROW controls, and press ENTER. Use ARROW controls to select the desired D.C. SENSITIVITY level shown by the number on the right. Press ENTER. D.C. SENSITIVITY levels should be selected carefully to allow smooth, stable and predictable operation while allowing for reasonable pinpointing.

A.C. and D.C. Sensitivity Adjustments are traditionally the way to alter detection depth and stability. There are other methods available in the PRO OPTIONS under SIGNAL (TRANSMIT, RECEIVE), PREAMP GAIN.

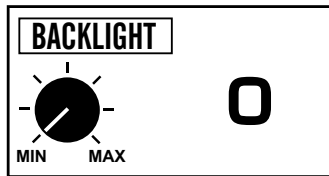

Tip - Use only when needed, and only as bright as needed, for acceptable display visibility. Backlight use will decrease battery life. The brighter the level, the higher the battery usage.

CAUTION

If the instrument is turned ON and the EMERGENCY BACKLIGHT sequence is used, the BACKLIGHT will stay ON only while you stay in that program. Pressing MENU and selecting another program will turn BACKLIGHT OFF, if BACKLIGHT is not also ON in that particular program. If in the dark at the time the instrument is turned ON, you may need to squeeze and release the TRIGGER and then use the EMERGENCY BACKLIGHT sequence. You can then find the program you desire, press ENTER, press ENTER for Air Balance, and press ENTER for Ground Balance. Use the EMERGENCY BACKLIGHT ON sequence a second time if the BACKLIGHT fades in that program. Unlike past Spectrum® instruments, the Spectrum® XLT® BACKLIGHT is no different than any of the other adjustments. It can be saved in the custom programs or short term volatile memory. However, factory preset programs use the OFF (0) setting as a default (standard setting).

9. Backlight

Used in dark conditions to light the display, improving visibility.

Select BACKLIGHT with the ARROW controls and press ENTER. Use the ARROW controls to select the desired BACKLIGHT level. The BACKLIGHT level will be visible on the display. The current level is shown on the right side of the display. The graphic control knob shows the relationship of the current setting to minimum and maximum levels. Minimum is 0 (no light). The maximum backlight setting will reduce battery life by as much as 50% depending on the type of batteries and how long it is used. Lower BACKLIGHT settings will have significantly less drain on battery life.

When the detector is first turned on, it is normal for the backlight to be on during the opening display and BATTERY CHECK. If the BACKLIGHT is off, it will fade when the MAIN MENU display appears. If the BACKLIGHT is ON, it will continue until turned off manually or a different program is selected. BACKLIGHT can be saved as part of a custom program, for example a NIGHT HUNT program.

When Backlight is ON and the TRIGGER is squeezed and released to begin searching, "BACKLIGHT ON" will appear continually on the display to warn you of the extra battery duty.

EMERGENCY BACKLIGHT - If in the dark you cannot see the display to turn the BACKLIGHT on, holding the TRIGGER and pressing MENU will bring up the BACKLIGHT adjustment screen. Release the TRIGGER and press ARROW *up* to select a level you can see the display. Squeeze and release the TRIGGER to continue.

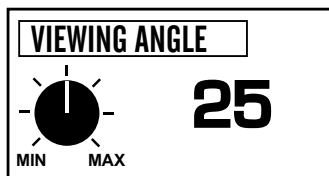

Tip - In cold temperatures the display typically will become slower at responding. Settings toward MAX (higher numbers) speeds the display and improves visibility at cool temperatures. In warm temperatures or intense direct sunlight, the display may become difficult to see. Settings toward MIN (lower numbers) will improve visibility of the display in all but extreme situations. If large variations in conditions result throughout the day or night's search, you may have to make several VIEWING ANGLE adjustments to maintain good display visibility.

10. Viewing Angle

Adjusts the display for visibility in low or high temperature conditions.

Select VIEWING ANGLE with the ARROW controls and press ENTER, use the ARROW controls to make changes. The current level is shown on the right side of the display. The graphic control knob indicates the relationship of the current setting to minimum and maximum levels. Squeeze and release the TRIGGER to resume searching.

VIEWING ANGLE has no impact on battery life.

EMERGENCY VIEWING ANGLE PROCEDURE- If your detector has been in the cold or heat prior to use, you may not be able to see the display to adjust VIEWING ANGLE. Press the ON/OFF control, hold the TRIGGER and press ARROW *up*. You can then use the ARROW controls to find a VIEWING ANGLE level that allows you to read the display. Squeeze and release the TRIGGER to begin searching. Like the BACKLIGHT, you will lose your custom VIEWING ANGLE setting if you change Programs. You may need to use the EMERGENCY VIEWING ANGLE PROCEDURE to see the display. Select the program you desire, use the ENTER control to enter, Air/Ground Balance, then again use the EMERGENCY VIEWING ANGLE PROCEDURE if the display is unreadable. VIEWING ANGLE is preset at average levels in the factory preset programs. The display may be unreadable at either of the extreme settings in a particular environment. Custom VIEWING ANGLE settings will be saved when Custom Programs are stored for future use.

Pro Options (overview)

AUDIO

1. **RATCHET PINPOINTING** - Pinpoint feature, automatically de-tunes for center location.
2. **S.A.T. SPEED** - Self Adjusting Threshold or Auto-tune, automatically maintains threshold.
3. **TONE I.D.** - Assigns each V.D.I. target number its own special tone or sound.
4. **V.C.O.** - Pinpoint or non-discriminate feature, increases pitch or tone with target strength.
5. **ABSOLUTE VALUE** - *Bigfoot* or *Goldfoot* loop accessories only.
6. **MODULATION** - Motion modes produce the same, or different volume, based on target depth.

G.E.B./TRAC

7. **AUTOTRAC** - Automatically updates Ground Balance during searching.
8. **TRAC VIEW** - TRACK appears on right side of display during AUTO TRAC adjustments.
9. **AUTOTRAC SPEED** - Dictates when AUTO TRAC adjusts Ground Balance.
10. **AUTOTRAC OFFSET** - Positive or negative AUTO TRAC (over, or under kill).
11. **TRAC INHIBIT** - Prevents tracking the ground during target detection.
12. **COARSE G.E.B.** - (Manual Ground Balance) Coarse viewing, or overriding automatic.
13. **FINE G.E.B.** - (Manual Ground Balance) Fine viewing, or overriding automatic.

DISCRIMINATION

14. **DISC. EDIT** - Change V.D.I. (target reference numbers) accepted (detected), or rejected status.
15. **BLOCK EDIT** - Speeds EDIT by dragging ACCEPT or REJECT with ARROW controls.
16. **LEARN ACCEPT** - Target samples can be used to show or teach ACCEPT discrimination.
17. **LEARN REJECT** - Target samples can be used to show or teach REJECT discrimination.
18. **RECOVERY SPEED** - Speeds target responses, so close together targets each respond.
19. **BOTTLECAP REJECT** - How strongly the instrument rejects or breaks up on iron.

DISPLAY

20. **VISUAL DISC.** - Rejected V.D.I. numbers and ICONS do not appear on display.
21. **ICONS** - Graphic display representation of metal targets, ON/OFF.
22. **V.D.I. SENSITIVITY** - Response intensity to produce a display indication & 3rd V.D.I. digit.
23. **D.C. PHASE** - Measurement of ground, or metal target, during pinpointing.
24. **GRAPH AVERAGING** - *SignaGraph*® information collects over multiples loop passes.
25. **GRAPH ACCUMULATING** - Emphasizes common or predominate *SignaGraph*®.
26. **FADE RATE** - Clears or fades non-current *SignaGraph*® information (bars).

SIGNAL (TRANSMIT, RECEIVE)

27. **TRANSMIT BOOST** - Selects the intensity of the signal transmitted from the loop.
28. **TRANSMIT FREQUENCY** - Alters operating frequency to avoid interference.
29. **PREAMP GAIN** - Selects the intensity of the signal received from the loop.

Pro Options

MAIN MENU Screen

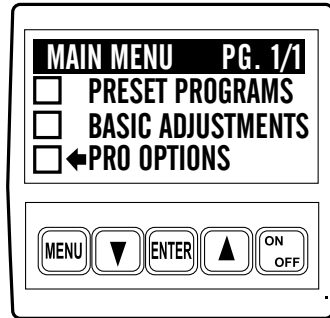

Pro Options Sub Menu #1

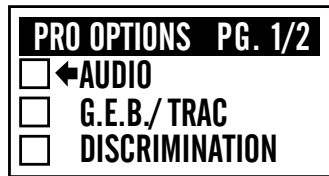

Pro Options Sub Menu #2

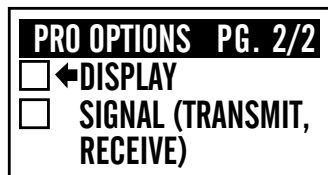

CAUTION

Be aware that changes you make to a Program are only in effect as long as you continue using that Program. If the detector is turned OFF, the Trigger must be squeezed and released to recover short term (volatile) memory upon turning the detector ON. If you want to keep the changes you made to a specific program over an extended time period (days or weeks), or through battery changes, the entire Program must be saved in a Custom Program position.

Basics of Pro Options

The **PRO OPTIONS** are used to make the more intricate adjustments available on this model. The **PRO OPTIONS** are divided into five major categories of menus, structured similar to the Basic Adjustments. Methods of entry, adjustment, exit, and re-entry remain the same.

To enter the **PRO OPTIONS** from a search mode, press **MENU** and the **MAIN MENU** will appear. Use the **ARROW** controls to select **PRO OPTIONS** and press **ENTER**. The **PRO OPTIONS** menu will appear on the display. There are two pages to the **PRO OPTIONS** menu (PG. 1/2 *Page one of two*).

The **ARROW** controls are then used to select the desired **PRO OPTION** category.

The five major categories have options specific to their titles. For example, all the options under **AUDIO** have to do with the way the audio circuits of the instrument behave. Once a category has been selected and the **ENTER** control pressed, the **ARROW** controls can then be used to scroll through all the options even beyond that category i.e., beyond **PRO OPTIONS**, back to **PRESET PROGRAMS**, and **BASIC ADJUSTMENTS**. The categories will only reappear if **MENU** is again pressed, or at specific times during scrolling (to offer short cuts).

From this point forward, we will assume that you know how to use the **MENU** control, the **Arrow Controls** to make a selection, the **ENTER** control to enter or select that option, the **Arrow Controls** to make adjustments, and the **MENU** to exit. Remember, squeezing and releasing the trigger returns to a search mode. **Arrow Controls** can be used to return from the search mode to the last menu or adjustment display used.

RATCHET PINPOINTING
<input checked="" type="checkbox"/> ON
<input type="checkbox"/> OFF
TO CHANGE PRESS ENTER

Tips - Use the ON setting until experienced at pinpointing.

(Audio section)

1. Ratchet Pinpointing

Pinpointing feature, automatically de-tunes for easy target-center locating.

ON - Automatically aids in pinpointing. When the TRIGGER is squeezed and held for pinpointing, RATCHET PINPOINTING will shrink the size of the signal as the loop is passed over the target area several times. The signal will not fade completely unless the loop is moved too far away from the target center.

OFF - When OFF, the signal will remain original size giving some indication of its size and shape. Manual shrinking is completed by squeezing and releasing the TRIGGER several times as the loop is passed over the target. Manual shrinking can completely eliminate the target. If the target no longer responds after manual shrinking, move the loop away from the target, squeeze and release the TRIGGER, and again sweep the loop over the area. If the target is a metal, it should again respond.

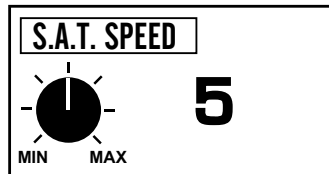

Tips - Recommended for most conditions as it provides greater stability particularly in non-discriminate modes or when sensitivity levels are maximized. Typically, faster S.A.T. SPEEDs (higher numbers) improve performance in more mineralized ground. Slower S.A.T. SPEEDs (lower numbers) improve performance in milder ground conditions.

(Audio section)

2. S.A.T. Speed

Self-Adjusting Threshold (auto-tune) smooths the THRESHOLD, OFF (0), or ON (1-10).

Without S.A.T. SPEED (a setting of 0), changes in the ground (and the passage of time) will tend to produce changes in the THRESHOLD sound. The TRIGGER will have to be squeezed and released repeatedly to maintain the THRESHOLD. This is particularly noticeable in non-discriminate modes, although S.A.T. SPEED will also tend to add stability to discriminate modes. S.A.T. SPEEDs 1 through 10 will automatically correct for such THRESHOLD changes.

S.A.T. (auto-tune) is a feature that has been used on metal detectors dating back to the 1970's. It adds a loop-motion requirement to modes which are ordinarily non-motion. It is also known to produce some variations in the responses to hot rocks (rocks more mineralized than the surrounding ground) which change with different speed selections.

Only enough S.A.T. SPEED required to maintain stability is recommended. Typically normal coin searching requires slower (lower number) speeds, beach hunting and relic hunting require slightly faster speeds (higher numbers), and prospecting requires the fastest settings (highest numbers).



Tips - Great for coin, jewelry, and relic searching. Can be used in combination with MIXED MODE.

(Audio section)

3. Tone I.D.

Assigns each V.D.I. number its own distinct tone or pitch. Target ranges can easily be identified by their sound. The higher the V.D.I. number, the higher the pitch of their sound. Reject targets still break up or "cut-out".

Tone I.D. is used in the discriminate or motion modes. When ON, each V.D.I. target number has its own audio frequency or pitch (191 different pitches). The higher the V.D.I. number, the higher the pitch. Where a target indicates on the V.D.I. scale can be immediately recognized. The sound that rejected targets produce will still be canceled or modified (broken up) by the discriminate circuit.

The 191 different pitches or tones activated with TONE I.D. cannot be adjusted as to their pitch. Each V.D.I. number's sound is predetermined by the factory and is not adjustable, nor will they shift with TONE (AUDIO FREQUENCY) adjustments. TRANSMIT FREQUENCY settings will add slight variations to these tones.

(Audio section)

4. V.C.O.

Voltage Controlled Oscillator produces a higher pitched tone the stronger the target becomes.

Voltage Controlled Oscillator is a feature that will only work in the non-discriminate modes. When it is ON, the stronger the response the higher the pitch of the sound. An excellent aid in pinpointing, V.C.O. will only function when the trigger is squeezed for pinpointing when activated in a discriminate mode.

D.C. SENSITIVITY settings will dramatically change the performance of V.C.O. D.C. SENSITIVITY settings above a level of 35 may peak the audio pitch too soon to allow V.C.O. to be useful. D.C. SENSITIVITY settings of 35 or below (lower numbers) are recommended.



Tips - The best aid available for pinpointing. Also can work well in combination with MIXED MODE to more easily indicate when the non-discriminate channel is operating.

ABSOLUTE VALUE
<input type="checkbox"/> ON
<input checked="" type="checkbox"/> OFF
TO CHANGE PRESS ENTER

Tips - Turn ON if elongated *Bigfoot* or *Goldfoot* loops (differentiating designs) have been installed.

MODULATION
<input checked="" type="checkbox"/> ON
<input type="checkbox"/> OFF
TO CHANGE PRESS ENTER

Tips - If you have excellent hearing and want to single out deep targets by their lower-volume responses, use modulation. ON is the default (standard setting) for all factory Preset Programs. If your hearing isn't the best, the OFF setting is recommended.

(Audio section)

5. Absolute Value

Bigfoot, and *Goldfoot* loop use.

Absolute Value is included to enhance the performance of specialty loop (*Bigfoot* and *Goldfoot*) designs. Absolute Value increases the detection area of these loops in the non-discriminate modes to their entire length. Use of **Absolute Value** is not recommended for round-loop designs.

(Audio section)

6. Modulation

Allows motion modes to produce different volume levels based on target depth.

Modulation is used in the discriminate or motion modes. When ON, it allows the depth of the target to dictate the volume of the response. Thus deep targets can be easily recognized by their lower-volume sound. If OFF, the discriminate or motion modes will produce the same volume of response on all detected targets regardless of depth. The use of MODULATION allows for the singling out of deep targets in the standard discriminate mode. It saves time by eliminating the checking of each target with the depth indication in the pinpoint mode.



Tips - Use ON for most search conditions.

(G.E.B./Trac section)

7. AutoTrac

AUTO TRAC™ allows the instrument to automatically readjust the Ground Balance setting during searching. This readjustment allows for natural occurring changes in the ground mineral of an area. By maintaining an accurate Ground Balance, detection depth and stability are enhanced. AUTO TRAC™ is recommended for typical search conditions. If, however, a great deal of decomposed man-made iron is encountered, AUTO TRAC™ OFF, or a reduced AUTO TRAC™ SPEED is advised. AUTO TRAC™ operation is affected by TRAC INHIBIT.

(G.E.B./Trac section)

8. Trac View

When ON, "TRACK" appears on right side of display when AUTO TRAC™ makes adjustments to the Ground Balance setting.



Tips - Use when experimenting with different TRAC SPEEDs to determine if, and how often, AUTO TRAC™ automatically adjusts Ground Balance.

TRAC VIEW offers a way to observe Autotracking. When ON, "TRACK" will appear momentarily on the right-hand side of the display just above the SignaGraph™ while AUTO TRAC is adjusting. This information is valuable when attempting to determine an appropriate Trac Speed. It may also be a valuable aid in determining the relative ground conditions. Re-occurring "TRACK" would indicate difficult ground. In average ground it is desirable to see some *tracking* occur (see TRAC SPEED).

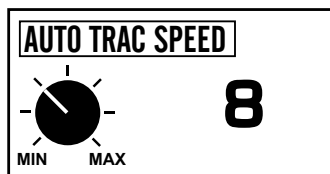

Tips - It is desirable to select a TRAC SPEED that tracks the ground once every three to five sweeps of the loop however, this may not be possible in extremely consistent, or extremely inconsistent ground conditions, which may TRAC less or more than this desired standard.

(G.E.B./Trac section)

9. Trac Speed

Dictates when AUTO TRAC™ adjusts Ground Balance.

Trac Speed allows adjustment of the amount of ground mineral change required to cause Autotracking to occur. At slower speeds (lower numbers) it takes a significant change in the ground to cause tracking to occur. At faster speeds (higher numbers) it takes very little change in the ground mineral to cause tracking to occur. The end result, more tracking occurs at higher numbers than at lower numbers. Too much tracking can cause errors in the ground balance setting. Not enough tracking can result in the ground balance setting never catching up with changing ground. TRAC VIEW is used to see how much tracking is occurring. Generally, a faster (higher number) TRAC SPEED is needed for more consistent ground conditions. Slower TRAC SPEEDS (lower numbers) is needed for more inconsistent ground conditions. "TRACK" appearing every three to five sweeps of the loop is the ideal setting when the ground conditions will allow.

(G.E.B./Trac section)

10. Trac Offset

Allows AUTO TRAC™ to track ground minerals either positive or negative in relationship to the correct setting (under, or over kill).

TRAC OFFSET allows the AUTO TRAC™ feature to track the ground slightly more or less than what would normally be considered perfect, mostly for experts that prefer a slight offset.

A slightly positive offset can be used to enhance the responses of small metals (gold nuggets) in highly-mineralized ground. Positive is indicated by a slight increase in threshold as the loop approaches the ground in the all-metal mode. Discrimination and depth may also be improved.

A negative offset may be used to eliminate particularly troublesome "hot rocks" in areas that are otherwise difficult to search. Negative offset is indicated by a loss or slight decrease in the threshold as the loop approaches the ground in the all-metal mode.

(G.E.B./Trac section)

11. Trac Inhibit

Prevents AUTO TRAC™ from tracking the ground during target detection.

TRAC INHIBIT ON prevents the AUTO TRAC™ feature from altering Ground Balance during the detection of targets. This prevents the possibility of tracking to the corrosion associated with most metals. TRAC INHIBIT ON is recommended for most searching conditions. Some metals do not corrode (GOLD) and since tracking is extremely important in high mineral conditions, the ability to turn TRAC INHIBIT OFF is available. OFF is automatically selected in the Prospecting Program and is recommended for prospecting.

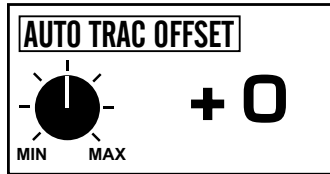

Tips - Recommended only for experienced operators who fully understand ground rejection.



Tips - ON for most search conditions, OFF for prospecting.

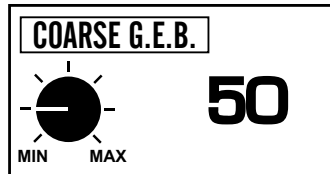

Tips - Use for controlled reactions to specific minerals or hot rocks.

(G.E.B./Trac section)

12. Coarse G.E.B.

(Manual Ground Balance) Allows viewing the current automatic Ground Balance setting (Air/Ground Balance) and/or manual overriding of the automatic Ground Balance.

COARSE & FINE G.E.B. (Ground Exclusion Balance, or ground rejection) allows manual override of the automatic balancing features to select a specific Ground Balance setting. COARSE allows major adjustments. FINE allows minor adjustments near the COARSE setting.

Before attempting manual Ground Balance adjustments, turn off AUTO TRAC™ since it will alter any manual changes you make. Manual Ground Balance will begin at the setting selected by the automatic (Air/Ground Balance) sequence. An Automatic Air/Ground Balance performed after manual adjustment will cancel the manual setting. To maintain a manual setting, the Automatic Air/ Ground sequence must be avoided by squeezing and releasing the TRIGGER when, and if, the Air Balance instruction appears. Air Balance instructions may appear during Basic Adjustment or Pro Options selections following the manual adjustment.

When manually adjusting the Ground Balance, it is necessary to make an adjustment in COARSE and/or FINE, then squeeze and release the TRIGGER. The TRIGGER can be held in, and the loop lowered and lifted over the ground to check for a change in sound which would indicate imperfect Ground Balance. To return to the Ground Balance display for further adjustment, press either of the ARROW controls. When perfectly Ground Balanced in a search mode, the TRIGGER can be squeezed and held, and the loop lowered and lifted with very little change in the threshold hum.

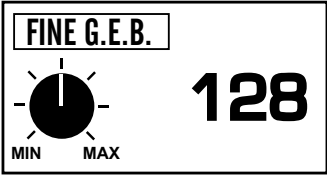

Tips - Use for controlled reactions to specific minerals or hot rocks.

(G.E.B./Trac section)

13. Fine G.E.B.

FINE G.E.B. is used to make smaller adjustments to the Ground Balance range on either side of the COARSE setting. The FINE setting combines with the COARSE setting to determine the actual ground rejection level. To determine exactly what level the automatic Air/Ground sequence selected, it is necessary to check both COARSE and FINE levels.

Manual Ground Balance will rarely be used for perfect balancing as the automatic balance is extremely reliable. It is generally used to offset Ground Balance for the same reasons AUTO TRAC™ OFFSET is used.

In COARSE or FINE, lower numbers indicate a Ground Balance setting toward the negative side of the V.D.I. scale (iron). Larger numbers indicate a Ground Balance setting toward the positive side of the V.D.I. chart (salt). Bad ground conditions (high mineralization) may be described as either *magnetic* (negative or low numbers) or *conductive* (positive or high numbers). COARSE and FINE settings of 0 represent a ground rejection similar to a V.D.I. number of -95. COARSE and FINE settings of 255 represent a ground rejection level similar to a V.D.I. number of +10. This V.D.I. range from -95 to +10 represents the ground rejection range of this instrument. If ground balance (either automatic or manual) occurs near the 255 COARSE setting, significant loss in sensitivity can be expected to targets which indicate in the V.D.I. number range of 1 to 10. However, manual ground balance doesn't exactly work like a discriminator, where V.D.I. numbers are simply REJECTED. The actual phase of Ground Balance is out of sequence with most targets; thus some responses will occur even if COARSE & FINE G.E.B. are matched exactly to a particular targets V.D.I. number.



Tips - The factory Preset Programs have all the major DISCRIMINATION EDIT set-ups already defined and ready for you to use. Major changes in ACCEPT and REJECT targets should be selected by choosing one of these factory programs. EDIT allows customizing for specific or unusual targets you may want to either ACCEPT or REJECT.

DISCRIMINATION - Will have a greater impact on how the instrument operates than any other feature. Audio Discriminate ON/OFF is located in the BASIC ADJUSTMENTS, (page 19).

DISC. EDIT and **BLOCK EDIT** are exceptions to the key-stroke rule in that they do not have a graphic control knob. However, ENTER must still be pressed before adjustments are possible.

(Discrimination section)

14. Disc. Edit

Allows for changing which targets V.D.I. or reference numbers are ACCEPTed (*detected*), or REJECTed, (*discriminated out*) within the current Program you are using.

Select DISC. EDIT and press ENTER. Now use the ARROW controls to view the V.D.I. numbers from negative -95 to positive +95 that appear on the right side of the display. These are the same reference numbers that are listed on the top right-hand side of the control box (V.D.I. SCALE or target chart). For each V.D.I. number, a \surd will appear to the left indicating whether the current program will ACCEPT or REJECT targets that display that number.

Use the ENTER control to change any desired V.D.I. number to ACCEPT or REJECT status.

If you do not save the entire Program into a Custom position, the changes you make in EDIT are only in use as long as you continue to use that program. The only exception being the temporary short-term or volatile memory as previously described. If you make EDIT changes in Coin, and then switch to COIN & JEWELRY, you lose all editing you completed in the Coin Program. Each time a factory Preset Program is ENTERed, all unsaved settings are over-written by the factory recommended settings. Only the Custom Programs will save your custom settings through Preset Program selections.

Accepting certain V.D.I. numbers will have an impact on detection depth, particularly for very deep targets that are difficult for the display to identify. Positive +95 is one of these V.D.I. numbers. Some Preset Programs are set so that the positive +95 V.D.I. number is rejected. The display uses positive +95 for many different types of

targets it cannot readily identify. Therefore, if positive +95 is ACCEPTed, questionable targets may be dug that indicate this number and can produce some interesting recoveries. *A good tip regarding positive +95: If a target indicates 95, and the depth display indicates it as being fairly deep; dig it. If the depth display indicates it as being fairly shallow, it is more likely to be trash or a hot rock.*

The first 30 to 40 negative numbers below zero also impact detection depth. Most iron indicates further into the negative numbers. Thus the first 30 to 40 negative numbers can often be ACCEPTed without digging much iron. ACCEPTing from the positive numbers down as low as minus 30 to 40 has the largest impact on the lower end of the positive numbers. Sensitivity to small jewelry is increased however, sensitivity to foil is also increased. On a beach or in a park that has lots of small foil, ACCEPTing down to minus 30 to 40 may not be practical. While ACCEPTing these minus numbers, a reduced sensitivity setting may help eliminate some of these small bits of unwanted foil.

ACCEPTING all V.D.I. numbers will produce the best overall detection depth however, with the amount of trash in most areas, searching with no rejection is seldom practical. TONE I.D. and or MIXED MODE are more practical choices. The idea of discrimination is to ACCEPT V.D.I. numbers most likely to be valuables and to REJECT the V.D.I. numbers most likely to be trash. Digging ease, and acceptability in an area will also decide the amount of ACCEPTed V.D.I. numbers desired. No metal detector can reject all trash while accepting all valuables. The deeper you want to detect, the more trash you will need to accept and dig.

The detector sees metals electronically; thus some valuable and non-valuable targets may look identical to the detector. To select ACCEPT and REJECT V.D.I. numbers is to gamble that the areas you select for ACCEPT will be good targets, and the area you select for REJECT will be trash targets. A factory program which uses the law of averages usually produces more good targets than trash. The EDIT feature allows you to fine-tune the ACCEPT and REJECT settings for your area and types of desired targets, further improving these odds.



Tips - If more than a few V.D.I. numbers are to be changed, use BLOCK EDIT.

(Discrimination section)

15. BLOCK Edit

Speeds major EDIT changes by *dragging* ACCEPT or REJECT with ARROW controls.

Allows major EDIT changes to be completed quickly. EDIT is for individual V.D.I. number changes and/or viewing of the current settings. BLOCK EDIT is for changing multiple V.D.I. numbers, or ranges.

CAUTION: You cannot view settings without changing ACCEPT or REJECT status in BLOCK EDIT.

Select BLOCK EDIT with the ARROW controls and press ENTER. The ENTER control can be used to select either ACCEPT or REJECT. The ARROW controls can then be used to drag that ACCEPT or REJECT status as far as desired through the V.D.I. number range. When a V.D.I. number or range of numbers appear that you want set differently, stop dragging with the ARROWS, press ENTER to change the ACCEPT / REJECT status, and then drag that new status as far as you desire. ENTER changes ACCEPT / REJECT; ARROWS drag that ACCEPT / REJECT status; ENTER again changes ACCEPT / REJECT; ARROWS drag that new ACCEPT / REJECT status, etc.

BLOCK EDIT not only saves time if large sections of the V.D.I. target numbers are to be changed, it also allows peace of mind in the certainty of how all the V.D.I. numbers are set. In the same amount of time it takes to view all the V.D.I. number's current status in regular EDIT, you can set them the way you desire in BLOCK EDIT.



Tips - If searching for one specific target and an exact sample is available, BLOCK EDIT everything for reject then use LEARN ACCEPT to accept only that specific target. If using a standard program and a specific unwanted trash target is being detected, use the LEARN REJECT to change the program to reject it.

CAUTION

If you do not return to the LEARN selection screen and turn LEARN OFF, the detector will continue to learn (ACCEPT or REJECT) every metal target it encounters. *Selecting LEARN OFF after you have learned a target is extremely important.*

Iron alloys, such as steel bottle caps or nails, should never be used for this LEARN method of programming. Because of their inconsistent V.D.I. indications, iron alloys tend to scatter or otherwise confuse the discriminate program. If this occurs, it is best to turn the detector OFF, back ON, and re-ENTER the desired Program to return to the original factory pre-set discriminate settings.

(Discrimination section)

16-17. Learn Accept/Reject

Specific target samples can be used to show or teach the discriminator what metal targets you desire ACCEPT or REJECT.

Select LEARN ACCEPT or LEARN REJECT with the ARROW controls and press ENTER to turn LEARN ON. The current selection is indicated by the ✓ mark in square on the left of the display.

Once ON:

1. Squeeze and release the TRIGGER.
2. Show metal target sample or samples to the instrument by sweeping them one at a time in front of the loop until the desired accept or reject sound is heard.
3. Press either ARROW control to return to the LEARN selection display.
4. Press ENTER control to select LEARN OFF.
5. Squeeze and release the TRIGGER to return to a searching mode.

As with EDIT, LEARN changes will only be temporary until saved in a Custom position.

If LEARN has been used to develop a discriminate program, the ACCEPT or REJECT V.D.I. numbers can be reviewed by using the EDIT feature.

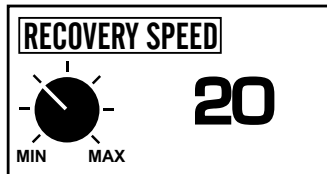

Tips - Use faster speeds (higher numbers) for trashy areas, slower speeds (lower numbers) for low trash areas and/or improved discrimination.

(Discrimination section)

18. Recovery Speed

Speeds target responses, so several targets that are close together can each respond.

When a metal is detected, it takes a fraction of a second for the detector to process the signal before it can respond to another metal target nearby. The time it takes to process the first metal target signal so that the second metal target signal can respond is called RECOVERY SPEED.

There are advantages and disadvantages to fast (high numbers) and slow (low numbers) RECOVERY SPEEDS. Faster RECOVERY SPEEDS work well in high trash areas. However, they will have some difficulties with very deep targets as well as double responses on shallow targets. Slower RECOVERY SPEEDS do not work very well in high trash areas. However, they will have better responses on very deep targets. Slower speeds also have more definitive discrimination sounds. A custom setting needs to be found that suits the preferences of the individual and the conditions in the area. As a general rule, the closer together the metal targets are in an area, the faster the recovery speed should be. The more spacing between targets, the slower the speed should be. Don't use the fast speed if you don't need to.

In very trashy areas it is recommended to switch to a loop smaller in size than the standard 9.5 inch black loop. Smaller loops offer better separation between targets. However, larger loops detect deeper and cover more area with each pass. RECOVERY SPEED combined with a smaller loop can be used to search severely trashy areas.

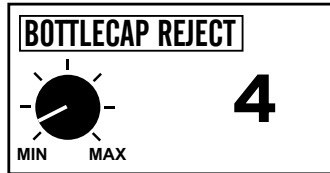

Tips - If having difficulties recognizing the broken sounds of iron, try increasing BOTTLECAP REJECT.

(Discrimination section)

19. Bottlecap Reject

Adjusts how strongly the instrument rejects or breaks up on iron.

Most starting programs use the minimum setting. As larger numbers are selected, more *bias rejection* against iron occurs.

The advantage of higher BOTTLECAP REJECT settings is that in high-trash areas more decisive iron rejection occurs. Trash becomes easier to identify by the broken sounds they produce.

The disadvantage of a high Bottlecap Rejection setting is if an iron target is close to a good metal, the high degree of *bias* against iron may cause the detector to cancel both responses. Another disadvantage is that all targets, iron and non-iron, tend to start sounding more broken at high levels of BOTTLECAP REJECT. The operator needs to fine tune BOTTLECAP REJECT according to their preferences and the conditions being searched.

Some ground conditions make it difficult for the instrument to recognize iron. BOTTLECAP REJECT allows compensation for these areas.



Tips - Typically you're not interested in the REJECTED target information. Eliminating it from appearing reduces or cleans up the display information you must interpret. ON is recommended for most search conditions.



(Display section)

20. Visual Disc.

When ON, REJECTED V.D.I. numbers and their associated ICONS are prevented from appearing on the display. When OFF, all V.D.I. numbers and associated ICONS appear.

VISUAL DISC. "ON" eliminates both the V.D.I. number **and** the ICON (NAIL, FOIL, PULL TAB, etc.) of **REJECTED** V.D.I. numbers from appearing on the display. In other words if Visual Discrimination is ON, and a specific target is rejected (for example 0-IRON) then 0-IRON will not appear on the display. If VISUAL DISC. is OFF, all the display indications will appear regardless of whether the specific V.D.I. number is ACCEPTED or REJECTED.

Visual Discrimination is based on the current discriminate program.

Visual Discrimination has the advantage of eliminating a large number of **REJECTED** V.D.I. numbers from appearing on the display. The disadvantage is that much of the visual display information will not appear for you to interpret questionable target responses.

(Display section)

21. Icons

Graphic representation of metal targets, "NAIL, FOIL, PULL TAB, SCREW CAP, COINS".

ICONS are designed for average use inside the USA. If searching in other countries, or in areas where such common types of targets are not expected, ICONS may be distracting. In such cases, this option allows the ICONS to be turned off.



Tips - The ICONS provide a quick way of reading the display information. ON is recommended. If you do not use these ICONS, selecting OFF will speed the remaining display indications.

(Display section)

22. V.D.I. Sensitivity

Controls how strong a target must respond to produce a display indication, and controls a third digit (fraction) of the V.D.I. number.

V.D.I. Sensitivity controls the intensity (strength) of the target signal needed to activate the display indications. A low V.D.I. Sensitivity setting would require a strong target signal to trigger the display indications. A higher V.D.I. Sensitivity setting would require very little target signal to trigger the display indications.

To provide greater specific target resolution, levels of 86 and above will provide a third V.D.I. digit (.0) to better evaluate targets. During EDIT only the first two digits can be programmed ACCEPT or REJECT.

As with all sensitivity levels, if set too high for the area, the detector will become unstable and the display indications unreliable.

Low ground mineralization is typically a good indication that high V.D.I. sensitivity settings are appropriate. Heavy mineralization or electrical interference are conditions where a lower V.D.I. Sensitivity setting is appropriate.

This feature is designed to allow adjustment of the display stability. However, because the instrument's display and audio tone are closely associated in many of the audio modes, the V.D.I. Sensitivity may increase or decrease overall audio sensitivity.

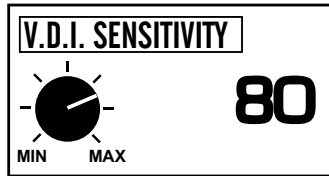

Tips - Lower V.D.I. SENSITIVITY level (smaller numbers) offer fewer and more reliable display indications. However, some deep targets may or may not respond with a display indication. Higher V.D.I. SENSITIVITY levels (higher numbers) produce more display indications, but less reliability. Levels of 86 and above produce a third V.D.I. digit (.0), providing greater resolution.

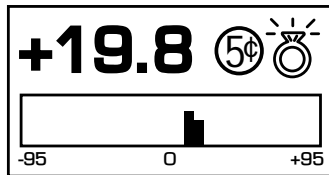

Third number (.8)



Tips - In specific ground conditions, certain Basic Adjustments and Pro Options may produce better performance. By measuring the ground and taking notes, such conditions may also be recognized in other areas and dealt with by using similar settings.

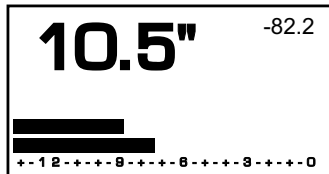

The D.C. Phase of the ground has a relationship to the proper Ground Balance setting. This is of particular interest to those who use the optional COARSE or FINE G.E.B. (Manual Ground Balance). Manual Ground Balance has a range that covers V.D.I. numbers from -95 - +10. A Manual Ground Balance Coarse setting of 0 equals a D.C. PHASE of negative -95. A Coarse setting of 255 equals a D.C. Phase of +10. As mentioned under COARSE and FINE G.E.B., Ground Balance is not the same as EDITING these V.D.I. numbers for REJECT. However, if your ground measures -90, ACCEPTING V.D.I. -90 will produce operational problems as the detector will see the ground as a target. With the same logic, if a target measures -90, and the ground measures -90, and the detector is Ground Balanced to this -90 ground, such a target will be virtually invisible to the detector. These conditions would be extremely rare however; the point is there must be a difference between the target and the ground for the target to be detected.

(Display section)

23. D.C. Phase

Measurement of the ground mineralization, or measuring the phase (V.D.I. reference number) of a specific metal target during pinpointing.

When D.C. PHASE is ON, and the TRIGGER squeezed and released, normal searching begins. When a target is located, or when the operator wants to measure a target or the ground, the TRIGGER is squeezed and held as if to pinpoint. When the loop is held stationary over the target or ground, the D.C. PHASE is shown on the upper-right side of the display. The depth reading can be used to help center the loop over a target for more accurate indications. The audio tone will also assist in centering the loop over the target.

Metal targets in the ground will produce a measurement which represents the target indication \pm the ground measurement. To measure the target alone, move the loop off to one side (being sure to hold the loop directly on top of the ground mineral), and release and re-squeeze the trigger. Then move the loop back over the target. This should allow a proper D.C. PHASE reading for the target alone.

The relationship between D.C. PHASE, Ground Balance, V.D.I. number and Discrimination is complex. Results are not always repeatable in varied ground conditions. Ground and target responses can distort the detection field of the loop in a number of ways, by bending, reflecting, absorbing and thus altering the phase and amplitude the detector measures. This in turn produces inconsistencies in the relationships of these features.

(Display section)

24. Accumulate

ON combines SignaGraph™ information over multiple loop passes, OFF shows SignaGraph™ information only from the last sweep of the loop.

Accumulate allows the SignaGraph™ to continually collect information. This collecting of information continues from one sweep of the loop to the next. Eventually, if only ACCUMULATE is selected, the SignaGraph™ will completely fill, requiring that the TRIGGER by squeezing and releasing to clear it so that further information may be viewed. FADE is suggested to be used in combination with ACCUMULATE so that non-current information gradually disappears and excessive TRIGGERing is not required. FADE will gradually reset or clear the SignaGraph™ to eliminate old information.

GRAPH ACCUMULATE

ON

OFF

TO CHANGE PRESS **ENTER**

Tips - ON is suggested, since it takes several sweeps of information to recognize trends.

If ACCUMULATE is OFF, and AVERAGE is OFF, then SINGLE SWEEP is active.

SINGLE SWEEP displays SignaGraph™ information received during the current sweep of the loop, no more and no less. The next sweep of the loop will clear all information from the SignaGraph™ and list the information received only within that sweep. Fade is not needed in the SINGLE SWEEP mode as each pass of the loop will clear the display and provide current information automatically. Several SignaGraph™ indication samples occur during each sweep of the loop. It is therefore normal to see one or more SignaGraph™ bars, even in the SINGLE SWEEP mode.

GRAPH AVERAGING

ON

OFF

TO CHANGE PRESS **ENTER**

Tips - Most beneficial when used in combination with ACCUMULATE. AVERAGE ON is suggested as it reduces indications uncharacteristic of a particular target, which may occur due to loop angle or target positioning in the ground.

(Display section)

25. Average

Emphasizes the most common or predominate SignaGraph™ indications.

AVERAGE *does not* necessarily allow showing of all the available information on the SignaGraph™. It *averages* the information received, and shows this average on the SignaGraph™. When used in combination with ACCUMULATE it has more information to average, which results in more accurate indications of trends. FADE is suggested to clear the display of old information, rather than excessive TRIGGERing.

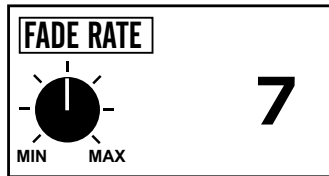

Tips - Recommended for all but the SINGLE SWEEP mode. Adjust the rate of FADing so that you have time to view the SignGraph™ prior to it resetting. However, do not set it so slow as to show non-current information.

(Display section)

26. Fade

Clears or fades non-current SignaGraph™ information (bars).

FADE allows past information to automatically clear or fade from the SignaGraph™. Without Fade, or with too slow of a FADE rate, the SignaGraph™ will fill with information that is no longer valid as you sweep through a search area.

A minimum setting of 0 equals no fade at all. The SignaGraph™ information will continue to appear until the trigger is squeezed and released. A maximum setting of 14 selects a very quick fade rate. The SignaGraph™ information will automatically clear from the graph quickly. Ideally, a Fade Rate should be selected that allows time to adequately view the SignaGraph™ information yet still clear the graph in a timely manner.

(Signal, Transmit, Receive))

27. Transmit Boost

Selects the intensity of the signal transmitted from the loop.

There is a transmit and a receive coil within the loop housing. If too much signal is transmitted for the ground conditions (magnetic and/or conductive ground), the signal will saturate the receiver and thus eliminate good ground penetration (depth). By turning OFF the TRANSMIT BOOST, ground penetration in most cases will return. The receive signal can then be optimized using PREAMP GAIN, to provide the best depth possible in such extreme ground conditions.

When "OVERLOAD" regularly appears on the display, there are either very large strong metal targets present or the ground mineralization is such that the detector cannot properly operate. Sweeping the loop higher above the specific OVERLOAD response will identify a target. When OVERLOAD appears on the display consistently due to ground minerals, selection of TRANSMIT BOOST OFF will improve depth and stability. During OVERLOAD the detector is not capable of responding to metal targets. The OFF setting in most cases will resolve such difficulties and provide detection capabilities in extreme conditions.

Every time the TRANSMIT BOOST is altered, the detector needs to be Air/Ground Balanced. Once in a search mode, simply press ENTER to Air/Ground Balance.

TRANSMIT BOOST
<input checked="" type="checkbox"/> ON
<input type="checkbox"/> OFF
TO CHANGE PRESS ENTER

Tips - Use ON unless "OVERLOAD" is often noted on the display, in which case the OFF setting should be selected. Make sure the OVERLOAD indication is not caused by a large metal target, that it is caused by the ground minerals.

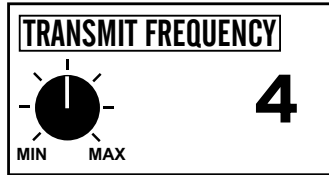

Tips - Use level number "4" (6592.5 Hz) unless interference results from other detectors. Move away from level "4" only far enough to prevent such interference.

(Signal, Transmit, Receive))

28. Transmit Frequency

Alters the normal operating frequency (6592.5 Hz) to avoid interference from other metal detectors operating close by. Operating frequency is the frequency the detector transmits and receives its signal.

Lower numbers equal lower frequencies,

$$1 = 6027.5 \text{ Hz}$$

$$2 = 6204.7 \text{ Hz}$$

$$3 = 6392.7 \text{ Hz}$$

$$4 = 6592.5 \text{ Hz}$$

Higher numbers equal higher operating frequencies,

$$5 = 6805.2 \text{ Hz}$$

$$6 = 7032.0 \text{ Hz}$$

$$7 = 7274.5 \text{ Hz}$$

Other metal detectors operating at the same frequency will cause interference. By shifting to a different frequency such interference can be avoided from detectors operating nearby.

The best performance will be achieved at the standard number "4" setting. If however, you cannot search due to interference from other detectors, use an alternate frequency.

Remember that once the trigger is squeezed and released to return to a search mode, the last option used can be accessed by pressing either of the arrow controls. This ARROW RETURN feature can be used to handily change TRANSMIT FREQUENCIES during a competition hunt.

(Signal, Transmit, Receive))

29. Preamp Gain

Selects the intensity of the signal received from the loop.

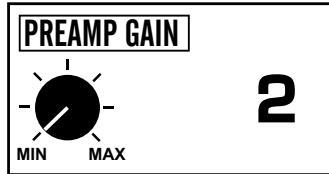

Tips - Higher levels increase detection depth. However, the detector must be stable to be able to recognize a target. OVERLOAD should not appear on the display when only ground minerals are present.

PREAMP GAIN (called *Signal Balance* on some models) is used to promote stability and performance. Like a sensitivity control, too much PREAMP GAIN will result in unstable operation and unreliable indications. **Unlike** a sensitivity control, PREAMP GAIN will have a substantial effect on OVERLOAD.

For maximum detection depth, fine tune the PREAMP GAIN to the highest number setting without causing OVERLOAD, and/or unstable operation. More adjustment levels (range) are available than what may be usable. You may never encounter an area where maximum PREAMP GAIN can be used. Electrical interference may make it difficult to receive an Air Balance at high PREAMP GAIN settings.

Selections such as MIXED MODE or AUDIO DISC OFF may not allow as high a PREAMP GAIN level as other selections. This is normal as some of these modes naturally see more targets and ground, and they may still provide superior performance and depth even with the lower PREAMP GAIN selection.

If TRANSMIT BOOST OFF has been selected, it is particularly advisable to fine tune PREAMP GAIN.

Every time the PREAMP GAIN level is changed, the detector needs to be re-ground balanced. Once in an operating mode, simply press ENTER to re-ground balance.

Preset Program Settings

	COIN	COIN& JEWELRY	JEWELRY &BEACH	RELIC	PROSPECT	
BASIC ADJUSTMENTS:						
TARGET VOLUME	56	56	56	56	56	
AUDIO THRESHOLD	23	23	23	23	23	
TONE (AUDIO FREQ.)	231	231	231	226	221	
AUDIO DISC.	ON	ON	ON	ON	OFF	
SILENT SEARCH	OFF	OFF	OFF	OFF	OFF	
MIXED-MODE	OFF	OFF	OFF	OFF	OFF	
A.C. SENSITIVITY	64	64	64	64	64	
D.C. SENSITIVITY	30	30	30	35	45	
BACKLIGHT	0	0	0	0	0	
VIEWING ANGLE	25	25	25	25	25	
PRO OPTIONS:						
<i>"AUDIO"</i>						
RATCHET PINPOINT	ON	ON	ON	OFF	OFF	
S.A.T. SPEED	5	5	9	7	9	
TONE I.D.	OFF	OFF	OFF	OFF	OFF	
V.C.O.	OFF	OFF	OFF	OFF	OFF	
ABSOLUTE VALUE	OFF	OFF	OFF	OFF	OFF	
MODULATION	ON	ON	ON	ON	ON	
<i>"G.E.B./TRAC"</i>						
AUTO TRAC™	ON	ON	ON	ON	ON	
TRAC VIEW	OFF	OFF	OFF	OFF	ON	
AUTO TRAC™ SPEED	8	8	14	14	18	
AUTO TRAC™ OFFSET	0	0	0	+1	+1	
TRAC INHIBIT	ON	ON	ON	ON	OFF	
COARSE G.E.B.	AUTO	AUTO	AUTO	AUTO	AUTO	
FINE G.E.B.	AUTO	AUTO	AUTO	AUTO	AUTO	
<i>"DISCRIMINATION"</i>						
DISC. EDIT	Reject	-95-+9	-95--31	-95--31	-95--30	-95--20
	Accept	+10-+27	-30--1	-30--1	-29--+95	-19-+94
	Reject	+28-+49	0-+7	0-+7	NA	+95
	Accept	+50-+94	+8-+95	+8-+95	NA	NA
	Reject	+95	NA	+95	NA	NA
BLOCK EDIT	Same Edit	Same Edit	Same Edit	Same Edit	Same Edit	
LEARN ACCEPT	OFF	OFF	OFF	OFF	OFF	
LEARN REJECT	OFF	OFF	OFF	OFF	OFF	
RECOVERY SPEED	20	20	20	20	20	
BOTTLECAP REJECT	4	4	1	1	1	
<i>"DISPLAY"</i>						
VISUAL DISC.	ON	ON	ON	ON	ON	
ICONS	ON	ON	ON	OFF	OFF	
V.D.I. SENSITIVITY	80	80	85	85	85	
D.C. PHASE	OFF	OFF	OFF	OFF	OFF	
GRAPH AVERAGING	ON	ON	ON	ON	ON	
GRAPH ACCUMULAT	ON	ON	ON	ON	ON	
FADE RATE	7	7	7	7	7	
<i>"SIGNAL"</i>						
TRANSMIT BOOST	ON	ON	ON	ON	ON	
TRANSMIT FREQ.	4	4	4	4	4	
PREAMP GAIN	2	2	2	2	2	

Custom Program Settings

	Custom 1	Custom 2	Custom 3	Custom 4	NOTES
BASIC ADJUSTMENTS:					
TARGET VOLUME					
AUDIO THRESHOLD					
TONE (AUDIO FREQ.)					
AUDIO DISC.					
SILENT SEARCH					
MIXED-MODE					
A.C. SENSITIVITY					
D.C. SENSITIVITY					
BACKLIGHT					
VIEWING ANGLE					
PRO OPTIONS:					
<i>"AUDIO"</i>					
RATCHET PINPOINT					
S.A.T. SPEED					
TONE I.D.					
V.C.O.					
ABSOLUTE VALUE					
MODULATION					
<i>"G.E.B./TRAC"</i>					
AUTO TRAC™					
TRAC VIEW					
AUTO TRAC™ SPEED					
AUTO TRAC™ OFFSET					
TRAC INHIBIT					
COARSE G.E.B.					
FINE G.E.B.					
<i>"DISCRIMINATION"</i>					
DISC. EDIT					
Reject					
Accept					
Reject					
Accept					
Reject					
BLOCK EDIT					
LEARN ACCEPT					
LEARN REJECT					
RECOVERY SPEED					
BOTTLECAP REJECT					
<i>"DISPLAY"</i>					
VISUAL DISC.					
ICONS					
V.D.I. SENSITIVITY					
D.C. PHASE					
GRAPH AVERAGING					
GRAPH ACCUMUL.					
FADE RATE					
<i>"SIGNAL"</i>					
TRANSMIT BOOST					
TRANSMIT FREQ.					
PREAMP GAIN					

Glossary

All-Metal: Any mode or control setting allowing total acceptance of all metal types, iron, aluminum, tin, nickel, gold, brass, lead, copper, silver etc...

Audio ID: Circuitry which produces different audio tones (pitch) for different target's conductivity.

Black Sand: One of the most extreme components of non-conductive, negative ground minerals. Magnetic. Also called Magnetite (Fe₃O₄) or magnetic iron oxide.

Cache: Any intentionally buried or secreted hoard of valuables.

Conductive Salts: One of the major mineral types which make up the positive ground minerals. Wet ocean salt/sand will produce a positive response due to its similar conductivity to metal.

Conductivity: The measure of a metal target's ability to allow eddy currents on its surface.

Depth: The greatest measure of a metal detectors ability to transmit an electromagnetic field into the ground.

De-tuning: Method of manually or automatically desensitize a metal detector so that it may locate the center of a target.

Discrimination: Circuitry which ignores or otherwise indicates, a specific target based on its conductivity/phase.

Drift: A loss or increase in threshold caused by temperature, time, or battery condition.

Eddy Currents: Small circulating currents of electricity.

Ferrous: Descriptive of any iron or iron bearing material.

Frequency: The number of complete alternating current cycles produced by the transmit oscillator per second.

Ground Balance: A state of operation in which specialized circuitry can ignore the masking effect ground minerals have over metal targets.

Hot Rock: A rock which contains a higher concentration of mineralization than the surrounding ground.

Matrix: Refers to the total volume (average) of ground penetrated by a metal detector.

Menu: Series of listings and prompts on a visual display designed to aid the operator in feature selection.

Metal: Metallic substances: iron, foil nickel, aluminum, gold, brass, copper, silver, etc...

Microprocessor: An electronic component that can be programed to perform certain electronic functions.

Mineralized Ground: Any soil containing conductive or magnetic components.

Mode: A condition of operation selected by the operator for specific functions.

Motion Mode: Any mode that requires loop movement to respond to metals.

Non-ferrous: Not of iron, any metal that is not iron.

Non-Motion Mode: Any mode of operation that doesn't require movement of the loop to respond to metal targets.

Phase: The length of time between eddy current generation sustained on a metals surface and the resulting secondary electromagnetic field effect on the loops receive winding.

Pinpointing: Finding the exact center of a metal target.

Reject: An indication of a target non-acceptance by silence or a broken sound.

Sensitivity: The measure or capacity of a metal detector to perceive changes in conductivity within the loops detection pattern.

Signal: An audio or display response alerting the operator that a target has been detected.

Stability: The ability of a metal detector to maintain smooth predictable performance.

Target: Refers to any object that causes an audio or display indication.

Visual ID: A feature which creates a visual indication to aid in identification of a target.

VLF (Very Low Frequency): A metal detector that operates in the 3-30 kHz frequency range.

WHITE'S ELECTRONICS INC. LIMITED WARRANTY STATEMENT

If within two years (24 months) from the original date of purchase, your White's detector fails due to defects in either material or workmanship, White's will repair or replace at its option, all necessary parts without charge for parts or labor.

Simply return the complete detector to the Dealer where you purchased it, or to your nearest Authorized Service Center. The unit must be accompanied by a detailed explanation of the symptoms of the failure. You must provide proof of date-of-purchase before the unit is serviced.

This is a transferable manufacturer warranty, which covers the instrument two years from the original purchase date, regardless of the owner.

Items excluded from the warranty are non-rechargeable batteries, accessories that are not standard equipment, shipping / handling costs outside the continental USA, Special Delivery costs (Air Freight, Next Day, 2nd Day, Packaging Services, etc.) and all shipping / handling costs inside the continental USA 90 days after purchase.

White's registers your purchase only if the Sales Registration Card is filled out and returned to the factory address soon after original purchase for the purpose of recording this information, and keeping you up-to-date regarding White's ongoing research & development.

The warranty does not cover damage caused by accident, misuse, neglect, alterations, modifications, unauthorized service, or prolonged exposure to corrosive compounds, including salt.

Duration of any implied warranty (e.g., merchantability and fitness for a particular purpose) shall not be longer than the stated warranty. Neither the manufacturer or the retailer shall be liable for any incidental or consequential damages. Some states however, do not allow the limitation on the length of implied warranties, or the exclusion of incidental or consequential damages. Therefore, the above limitations may not apply to you.

In addition, the stated warranty gives you specific legal rights, and you may have other rights which vary from state-to-state.

The foregoing is the only warranty provided by White's as the manufacturer of your metal detector. Any "extended warranty" period beyond two years, which may be provided by a Dealer or other third party on your detector, may be without White's authority, involvement and consent, and might not be honored by White's.

White's Authorized Service Centers

1 White's Electronics
1011 Pleasant Valley Rd.
Sweet Home, OR 97386
(541) 367 6121
Fax (541) 367 6629
nbaker@whiteselectronics.com

2 Electronic Exploration
700 South Main
Lombard, IL 60148
(630) 620-0618
Fax (630) 620-1005
Tol Free 800 392-3223*
akempf@mediaone.net

3 Geoquest
106 US Hwy 46
Saddlebrook, NJ 07663
(973) 772-7443
Fax (973) 772-7773
Tol Free 877 772-7443*
akempf@mediaone.net

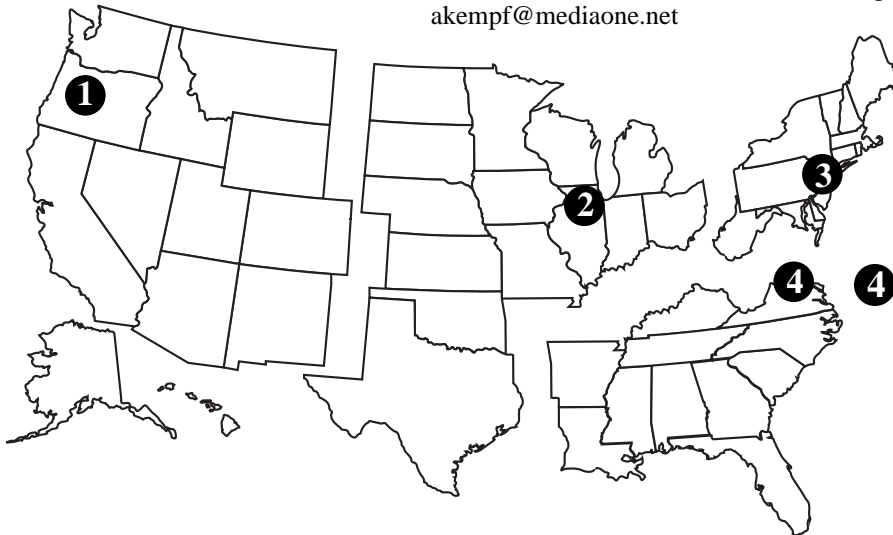

4 Centreville Electronics
13810 B Braddock Rd.
Centreville, VA 20121
(703) 631-0202
Fax (703) 222-8625
Tol Free 888 645-0202*
centelec@vwx.net

White's reputation has been built on quality products backed by quality service. Our Factory Authorized Service Centers are factory trained and equipped. They offer the same quality service as the factory. Service before and after the sale is the cornerstone of our customer relations.

Before shipping detectors for service

A. Contact your Dealer. There may be a quick, simple fix or explanation that will prevent having to send the detector in for service.

B. Double check the obvious, such as batteries, and try the detector in another area to be sure there is not interference.

C. Be sure to send all necessary parts with your detector, such as batteries and holders, as these items can result in symptoms.

D. Always include a letter of explanation about your concerns, even if you have talked to the Service Center by telephone.

E. Take care in packaging instruments for shipping. Always insure your package.

